

Product Image

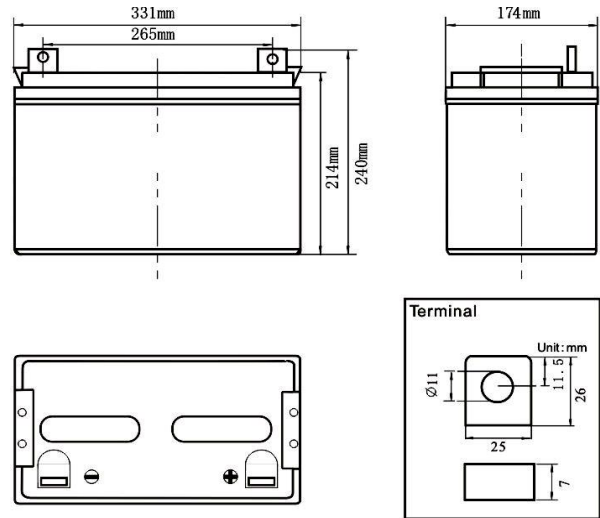

Product Dimensions



Characteristics

Nominal Voltage		12V
Nominal Capacity (10 hour rate)		80Ah
Capacity 25°C (77°F)	20 hour rate (4.44A)	88.8Ah
	5 hour rate (14.6A)	73.2Ah
	1 hour rate (53.2A)	53.2Ah
Internal Resistance	Full Charged Battery 25°C	$\leq 5.0m\ \Omega$
Capacity affected by Temperature (10 hour)	40°C (104°F)	102%
	25°C (77°F)	100%
	-20°C (-4°F)	82%
	-35°C (-31°F)	65%
Self-Discharge 25°C (77°F) Capacity	after 3 month storage	90%
	after 6 month storage	80%
	after 12 month storage	62%
Charge (Constant Voltage) 25°C (77°F)	Float	Initial Charging Current Less than 20.0A Voltage 13.6-13.8V
	Cycle	Initial Charging Current Less than 20.0A Voltage 14.4-14.9V

Packaging

Battery Dimensions	Length	331mm
	Width	174mm
	Height	214mm
	Total Height	240mm
Box Dimensions	Length	346mm
	Width	188mm
	Height	289mm
Quantity Per Box		1 PC per box
Net weight Per Cell		26.3kg±400g
Net weight Per Box		26.3kg
Gross Weight		26.7kg

Discharge Constant Current per Cell (Amperes at 77°F 25°C)

F.V/Time	5min	10min	15min	30min	45min	1h	2h	3h	5h	8h	10h	20h
1.60V	269.0	179.2	135.1	84.1	60.3	53.2	32.5	23.7	15.3	9.3	8.3	4.6
1.65V	248.0	165.2	129.5	81.8	58.7	51.8	31.9	23.3	15.1	9.3	8.2	4.6
1.70V	252.2	168.0	123.8	79.6	57.1	50.4	31.3	22.9	14.9	9.2	8.2	4.5
1.75V	222.8	148.4	118.2	77.3	55.5	49.0	30.5	22.3	14.6	9.1	8.1	4.5
1.80V	210.2	140.0	112.6	75.1	53.9	47.5	29.8	21.8	14.4	9.0	8.0	4.4

Discharge Constant Power per Cell (Watts at 77°F 25°C)

F.V/Time	5min	10min	15min	30min	45min	1h	2h	3h	5h	8h	10h	20h
1.60V	501.7	334.2	251.9	156.8	112.5	99.3	60.5	44.3	28.5	17.4	15.5	8.6
1.65V	462.5	308.1	241.4	152.6	109.5	96.6	59.4	43.4	28.1	17.2	15.4	8.6
1.70V	470.4	313.3	230.9	148.4	106.5	94.0	58.3	42.6	27.7	17.1	15.2	8.5
1.75V	415.5	276.8	220.4	144.2	103.4	91.3	56.9	41.6	27.3	16.9	15.1	8.4
1.80V	392.0	261.1	209.9	140.0	100.4	88.6	55.5	40.6	26.9	16.7	14.9	8.3

Note The above data are average values, and can be obtained within 3 charge/discharge cycles. These are not minimum values. Cell and battery designs/specifications are subject to modification without notice. Contact **US** for the latest information.

Performance Characteristics

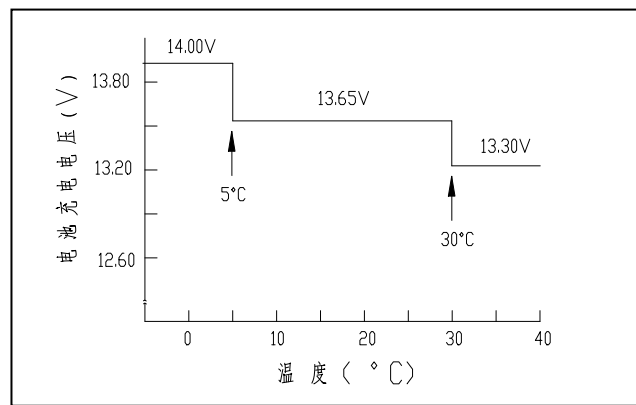
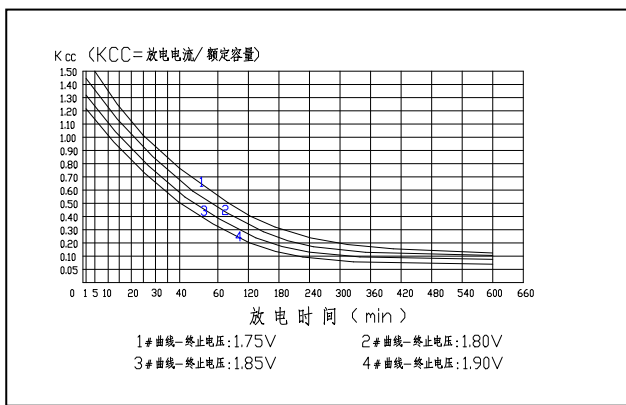
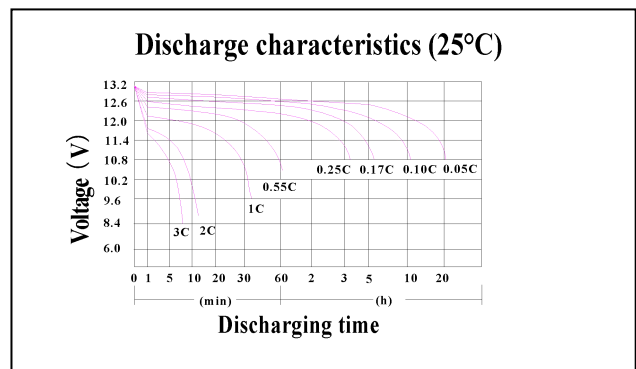
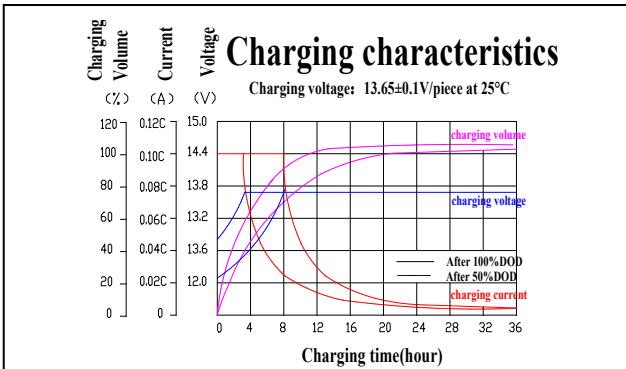
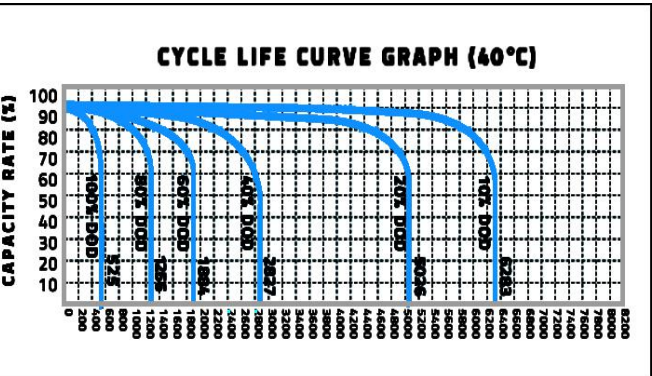
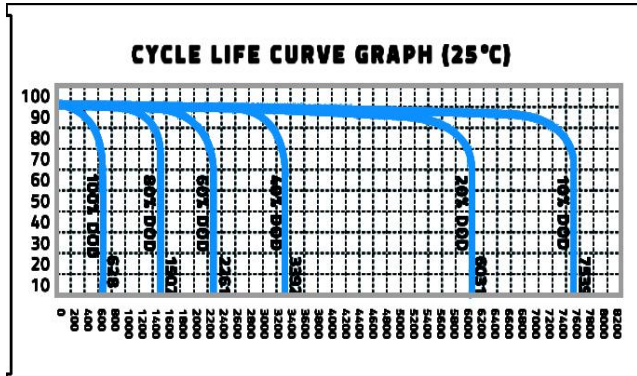
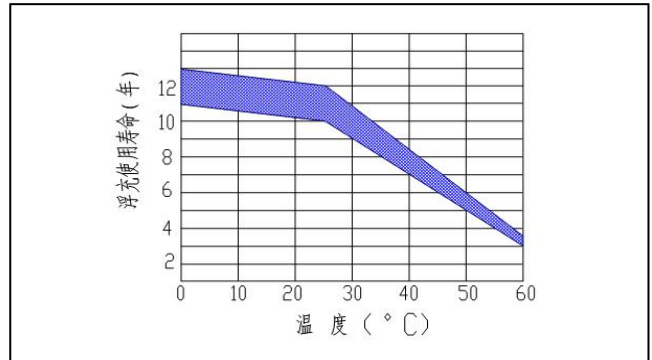
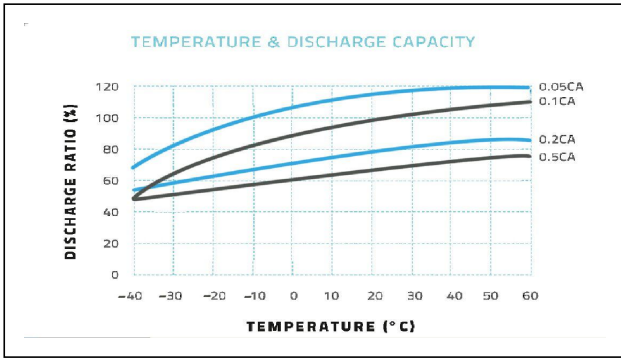

Battery Construction

Component	Positive plate	Negative plate	Container	Cover	Safety valve	Terminal	Separator	Electrolyte
Raw material	Lead dioxide	Lead	ABS	ABS	Si-Rubber	Copper	Fiberglass	Lead

Guangdong JiYi General Electric Co., Ltd.

Oversea sales office Tel: +86-020-84869873

Fax: +86-020-34628335

Domestic sales office Tel: 020-34628335

Fax: 020-34628335

E-mail:ge@gerch.cn