

### Product Image

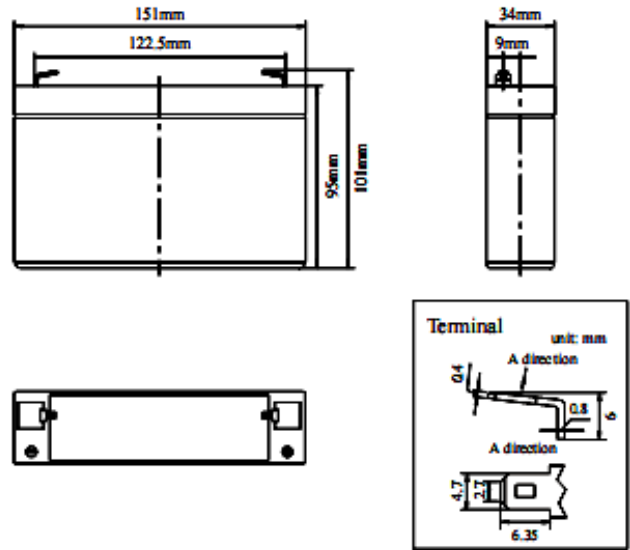

### Product Dimensions



### Characteristics

Nominal Voltage		6V
Nominal Capacity (20 hour rate)		8.5Ah
Capacity 25°C (77°F)	10 hour rate (0.81A)	8.13Ah
	5 hour rate (1.51A)	7.57Ah
	1 hour rate (5.6A)	5.6Ah
Internal Resistance	Full Charged Battery 25°C	≤16mΩ
Capacity affected by Temperature (10 hour)	40°C (104°F)	102%
	25°C (77°F)	100%
	0°C (32°F)	85%
	-15°C (5°F)	65%
Self-Discharge 25°C (77°F) Capacity	after 3 month storage	90%
	after 6 month storage	80%
	after 12 month storage	62%
Charge (Constant Voltage) 25°C (77°F)	Float	Initial Charging Current Less than 2.55A Voltage 6.8-6.9V
	Cycle	Initial Charging Current Less than 2.55A Voltage 7.2-7.5V

### Packaging

Battery Dimensions	Length	151mm
	Width	34mm
	Height	95mm
	Total Height	101mm
Box Dimensions	Length	382mm
	Width	320mm
	Height	114mm
Quantity Per Box		20 pcs per box
Net weight Per Cell		1.2 kg±50g
Net weight Per Box		24kg
Gross Weight		24.5kg

#### Discharge Constant Current per Cell (Amperes at 77°F25°C)

F.V/Time	5min	10min	15min	30min	45min	1h	2h	3h	5h	8h	10h	20h
1.60V	24.57	15.79	13.16	8.77	6.29	5.42	2.40	2.34	1.59	1.05	0.94	0.50
1.65V	24.11	15.50	12.92	8.61	6.18	5.32	2.35	2.30	1.56	1.03	0.92	0.49
1.70V	23.67	15.22	12.67	8.45	6.06	5.23	2.30	2.25	1.53	1.01	0.90	0.48
1.75V	23.22	14.93	12.44	8.30	5.95	5.13	2.26	2.21	1.50	0.99	0.88	0.47
1.80V	22.33	14.36	11.96	7.97	5.72	4.93	2.18	2.13	1.45	0.95	0.85	0.45

#### Discharge Constant Power per Cell (Watts at 77°F 25°C)

F.V/Time	5min	10min	15min	30min	45min	1h	2h	3h	5h	8h	10h	20h
1.60V	47.29	30.40	25.32	16.88	12.11	10.44	4.61	4.50	3.06	2.01	1.80	0.95
1.65V	46.43	29.84	24.86	16.58	11.89	10.25	4.52	4.42	3.00	1.98	1.77	0.94
1.70V	45.56	29.29	24.40	16.27	11.67	10.06	4.44	4.34	2.95	1.95	1.73	0.92
1.75V	44.70	28.74	23.94	15.96	11.45	9.87	4.36	4.26	2.89	1.90	1.70	0.90
1.80V	42.98	27.63	23.02	15.35	11.02	9.49	4.19	4.09	2.78	1.84	1.64	0.87

**Note** The above data are average values, and can be obtained within 3 charge/discharge cycles. These are not minimum values. Cell and battery designs/specifications are subject to modification without notice. Contact **US** for the latest information.

### Performance Characteristics

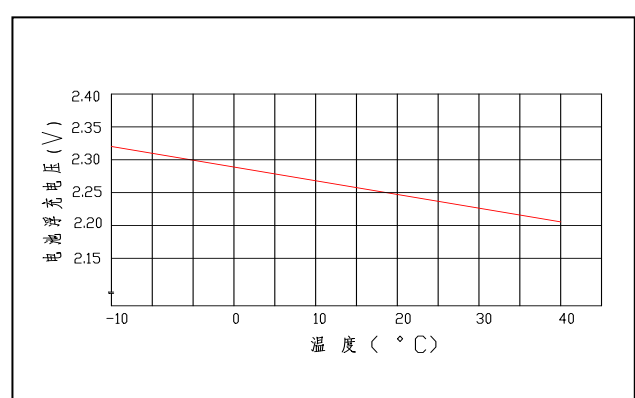
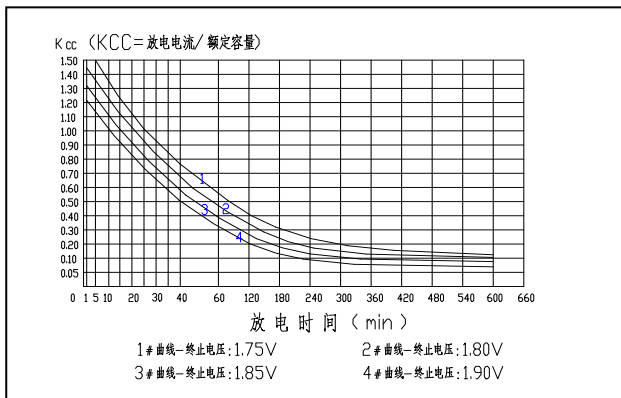
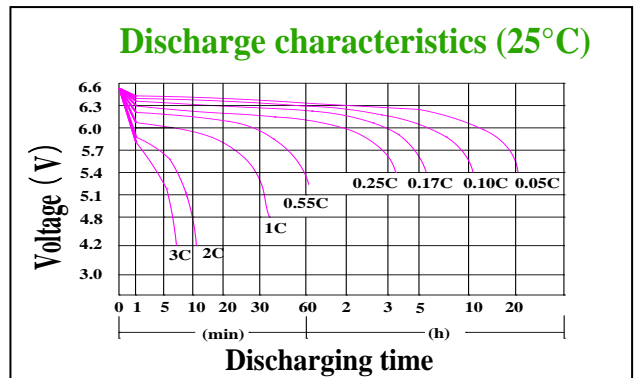
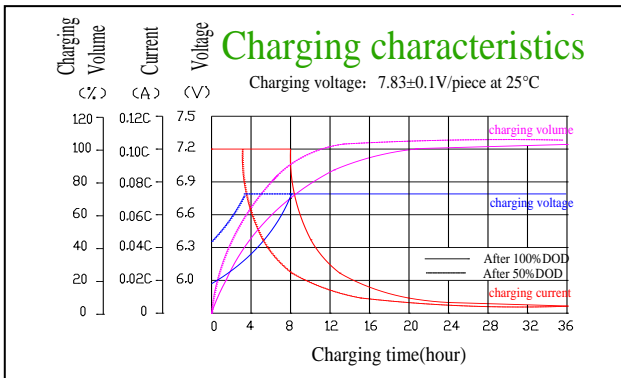
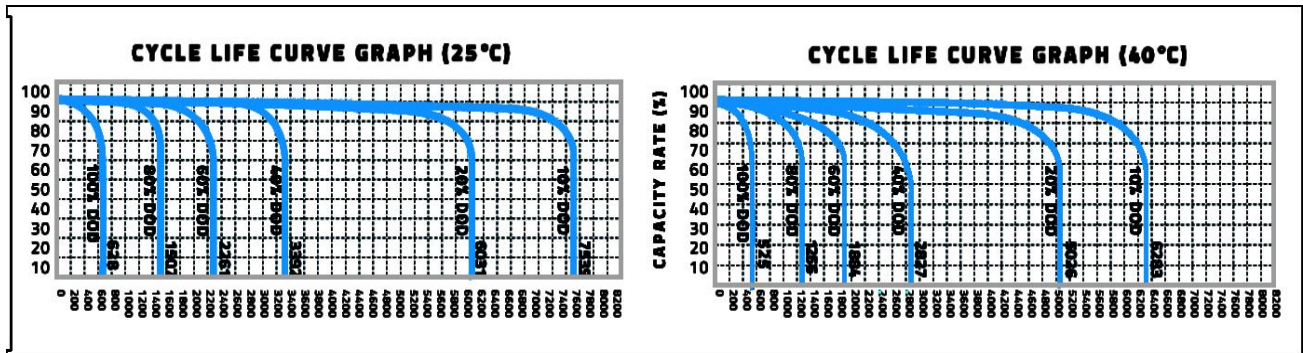
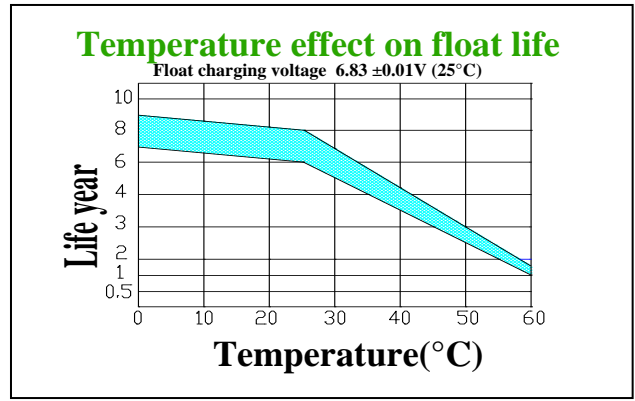
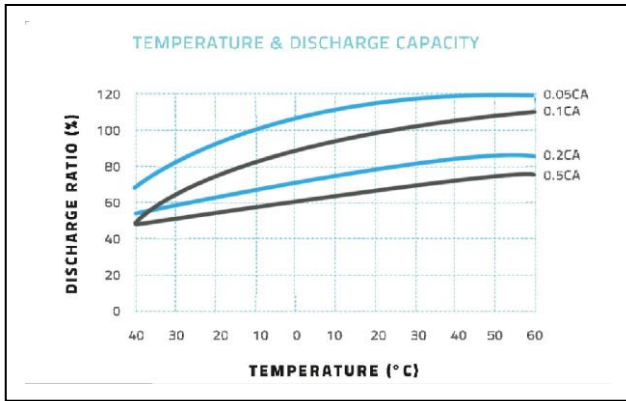

### Battery Construction

Component	Positive plate	Negative plate	Container	Cover	Safety valve	Terminal	Separator	Electrolyte
Raw material	Lead dioxide	Lead	ABS	ABS	Si-Rubber	Copper	Fiberglass	Silicon

**Guangdong JiYi General Electric Co., Ltd**

Overseas sales office Tel: +86-020-84869873 Fax: +86-020-34628335

Domestic sales office Tel: 020-34628335 Fax: 020-34628335

E-mail: ge@gerch.cn