

### Product Image

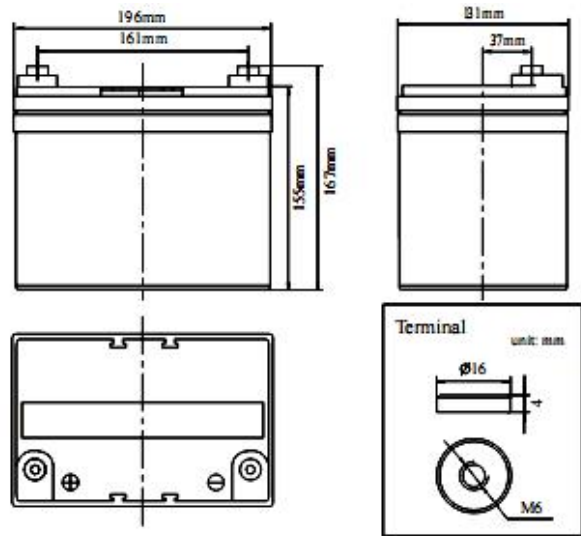

### Product Dimensions



### Characteristics

|   |                           |  |
|---|---------------------------|--|
| Nominal Voltage                                   |                           | 12V  |
| Nominal Capacity (20 hour rate)                   |                           | 35Ah   |
| Capacity<br>25°C (77°F)                           | 10 hour rate (3.2A)       | 31.5Ah   |
|   | 5 hour rate (5.7A)        | 28.3Ah   |
|   | 1 hour rate (19.4A)       | 19.4Ah   |
| Internal Resistance                               | Full Charged Battery 25°C | ≤12m Ω   |
| Capacity affected by<br>Temperature<br>(10 hour ) | 40°C (104°F)              | 102%   |
|   | 25°C (77°F)               | 100%   |
|   | 0°C (32°F)                | 85%  |
|   | -15°C (5°F)               | 65%  |
| Self-Discharge<br>25°C (77°F)<br>Capacity         | after 3 month storage     | 90%  |
|   | after 6 month storage     | 80%  |
|   | after 12 month storage    | 62%  |
| Charge<br>(Constant<br>Voltage)<br>25°C<br>(77°F) | Float                     | Initial Charging Current Less than 8.75A<br>Voltage 13.6-13.8V |
|   | Cycle                     | Initial Charging Current Less than 8.75A<br>Voltage 14.4-14.9V |

### Packaging

|                       |                 |               |
|-----------------------|-----------------|---------------|
| Battery<br>Dimensions | Length          | 196mm         |
|                       | Width           | 131mm         |
|                       | Height          | 155mm         |
|                       | Total<br>Height | 167mm         |
| Box<br>Dimensions     | Length          | 211mm         |
|                       | Width           | 144mm         |
|                       | Height          | 211mm         |
| Quantity Per Box      |                 | 1 PCs per box |
| Net weight Per Cell   |                 | 10.5 kg±3%    |
| Net weight Per Box    |                 | 10.5kg        |
| Gross Weight          |                 | 10.8kg        |

#### Discharge Constant Current per Cell (Amperes at 77°F 25°C)

| F.V/Time | 5min | 10min | 15min | 30min | 45min | 1h   | 2h   | 3h  | 5h  | 8h  | 10h | 20h  |
|----------|------|-------|-------|-------|-------|------|------|-----|-----|-----|-----|------|
| 1.60V    | 83.2 | 53.0  | 45.0  | 28.8  | 21.1  | 19.4 | 12.3 | 8.7 | 5.9 | 3.9 | 3.5 | 1.92 |
| 1.65V    | 81.6 | 52.1  | 44.2  | 28.2  | 20.8  | 19.1 | 12.1 | 8.5 | 5.8 | 3.8 | 3.4 | 1.89 |
| 1.70V    | 80.1 | 51.1  | 43.4  | 27.7  | 20.4  | 18.7 | 11.9 | 8.3 | 5.7 | 3.7 | 3.3 | 1.85 |
| 1.75V    | 78.6 | 50.1  | 42.6  | 27.2  | 20.0  | 18.3 | 11.7 | 8.2 | 5.6 | 3.7 | 3.3 | 1.82 |
| 1.80V    | 75.6 | 48.2  | 41.0  | 26.1  | 19.2  | 17.6 | 11.2 | 7.9 | 5.4 | 3.5 | 3.2 | 1.75 |

#### Discharge Constant Power per Cell (Watts at 77°F 25°C)

| F.V/Time | 5min  | 10min | 15min | 30min | 45min | 1h   | 2h   | 3h   | 5h   | 8h  | 10h | 20h |
|----------|-------|-------|-------|-------|-------|------|------|------|------|-----|-----|-----|
| 1.60V    | 160.1 | 102.1 | 86.7  | 55.4  | 40.7  | 37.4 | 23.7 | 16.7 | 11.3 | 7.5 | 6.7 | 3.7 |
| 1.65V    | 157.2 | 100.2 | 85.1  | 54.4  | 39.9  | 36.7 | 23.3 | 16.4 | 11.1 | 7.3 | 6.5 | 3.6 |
| 1.70V    | 154.3 | 98.3  | 83.6  | 53.3  | 39.2  | 36.0 | 22.9 | 16.1 | 10.9 | 7.2 | 6.4 | 3.6 |
| 1.75V    | 151.4 | 96.5  | 82.0  | 52.3  | 38.5  | 35.3 | 22.5 | 15.8 | 10.7 | 7.1 | 6.3 | 3.5 |
| 1.80V    | 145.5 | 92.8  | 78.8  | 50.3  | 37.0  | 34.0 | 21.6 | 15.2 | 10.3 | 6.8 | 6.1 | 3.4 |

**Note** The above data are average values, and can be obtained within 3 charge/discharge cycles. These are not minimum values. Cell and battery designs/specifications are subject to modification without notice. Contact **US** for the latest information.

### Performance Characteristics

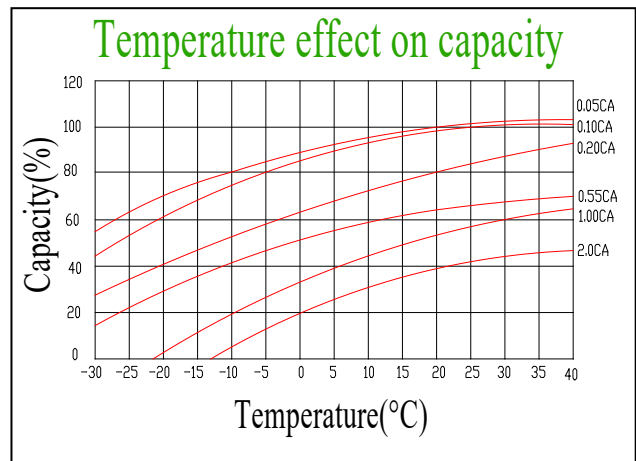
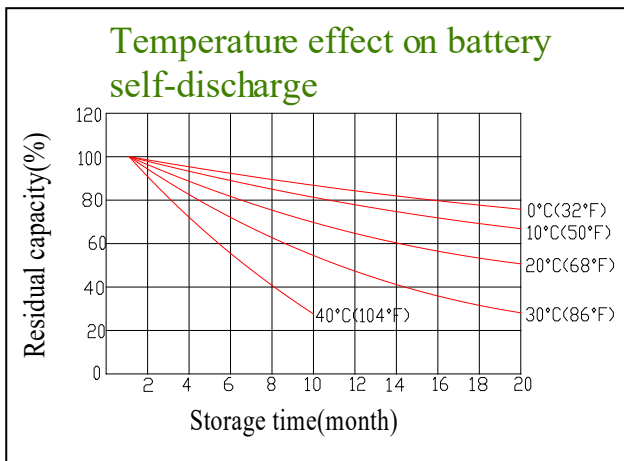
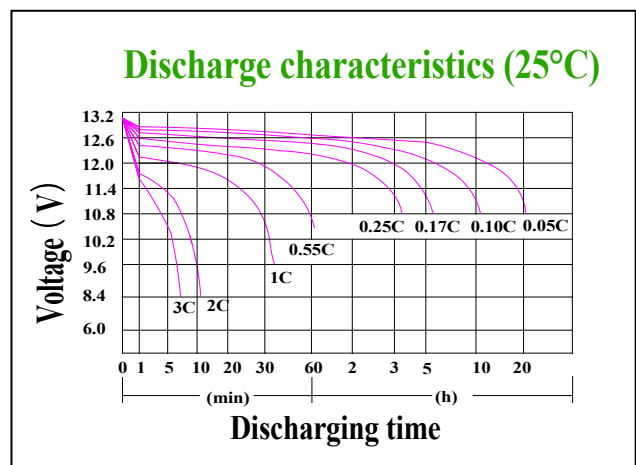
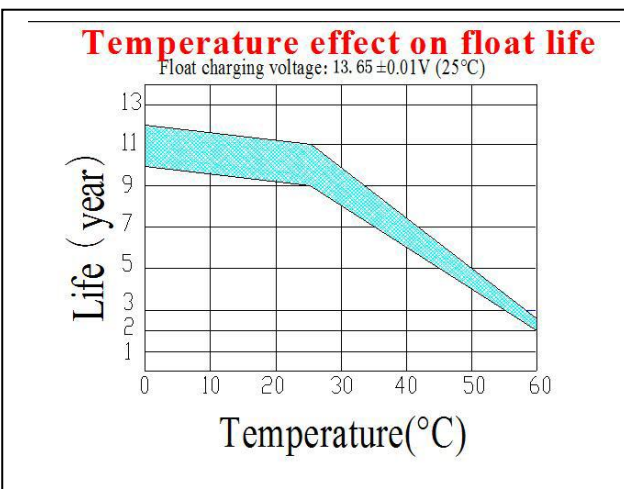
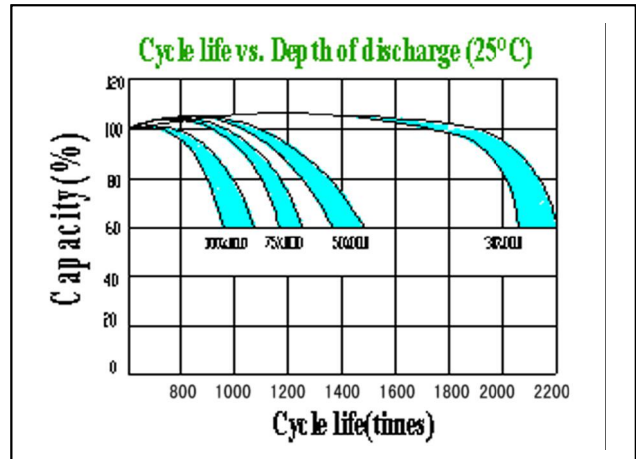
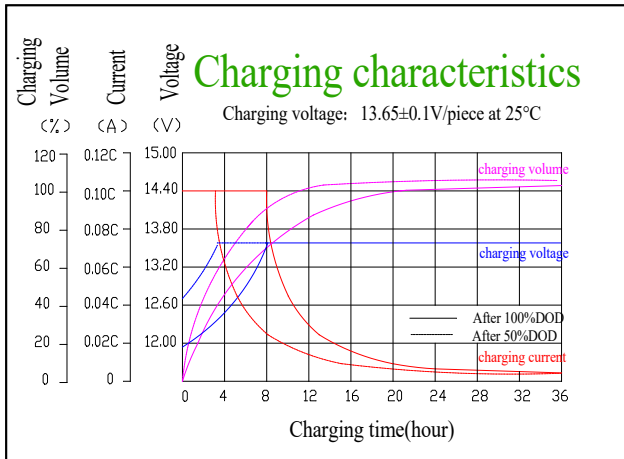

### Battery Construction

| Component    | Positive plate | Negative plate | Container | Cover | Safety valve | Terminal | Separator  | Electrolyte   |
|--------------|----------------|----------------|-----------|-------|--------------|----------|------------|---------------|
| Raw material | Lead dioxide   | Lead           | ABS       | ABS   | Si-Rubber    | Copper   | Fiberglass | Sulfuric acid |

**Guangdong JiYi General Electric Co., Ltd.**

Overseas sales office Tel: +86-020-84869873 Fax: +86-020-34628335

Domestic sales office Tel: 020-34628335 Fax: 020-34628335

E-mail: ge@gerch.cn