

Product Image

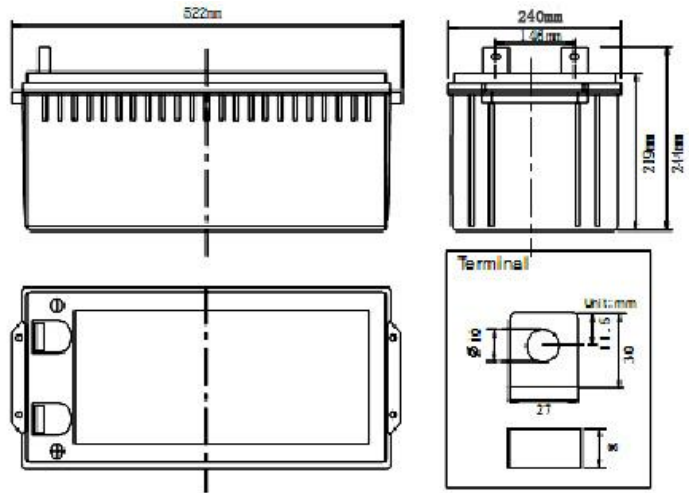

Product Dimensions



Characteristics

Nominal Voltage		12V
Nominal Capacity (10 hour rate)		240Ah
Capacity 25°C (77°F)	20 hour rate (12.8A)	266.4Ah
	5 hour rate (42.1A)	216Ah
	1 hour rate (153.0A)	142.5Ah
Internal Resistance	Full Charged Battery 25°C	≤2.5m Ω
Capacity affected by Temperature (10 hour)	40°C (104°F)	102%
	25°C (77°F)	100%
	-20°C (-4°F)	82%
	-35°C (-31°F)	65%
Self-Discharge 25°C (77°F) Capacity	after 3 month storage	90%
	after 6 month storage	80%
	after 12 month storage	62%
Charge (Constant Voltage) 25°C (77°F)	Float	Initial Charging Current Less than 57.5A Voltage 13.6-13.8V
	Cycle	Initial Charging Current Less than 57.5A Voltage 14.4-14.9V

Packaging

Battery Dimensions	Length	520mm
	Width	269mm
	Height	203mm
	Total Height	226mm
Box Dimensions	Length	537mm
	Width	255mm
	Height	299mm
Quantity Per Box		1 PC per box
Net weight Per Cell		63.0 kg±500g
Net weight Per Box		63.0kg
Gross Weight		63.5kg

Discharge Constant Current per Cell (Amperes at 77°F 25°C)

F.V/Time	5min	10min	15min	30min	45min	1h	2h	3h	5h	8h	10h	20h
1.60V	807.00	537.60	405.15	252.15	180.90	159.60	97.35	71.10	45.75	27.90	24.96	13.86
1.65V	744.00	495.60	388.35	245.40	176.10	155.40	95.55	69.90	45.15	27.75	24.72	13.73
1.70V	756.60	504.00	371.40	238.65	171.15	151.05	93.75	68.55	44.55	27.45	24.48	13.59
1.75V	668.25	445.20	354.60	231.90	166.35	146.85	91.50	66.90	43.80	27.15	24.24	13.46
1.80V	630.45	420.00	337.65	225.15	161.55	142.50	89.25	65.25	43.20	26.85	24.00	13.32

Discharge Constant Power per Cell (Watts at 77°F 25°C)

F.V/Time	5min	10min	15min	30min	45min	1h	2h	3h	5h	8h	10h	20h
1.60V	1505.10	1002.60	755.70	470.25	337.35	297.75	181.50	132.75	85.35	52.20	46.50	25.80
1.65V	1387.50	924.30	724.20	457.65	328.35	289.80	178.20	130.20	84.15	51.60	46.05	25.65
1.70V	1411.05	939.90	692.70	445.05	319.35	281.85	174.90	127.80	82.95	51.15	45.60	25.35
1.75V	1246.35	830.25	661.20	432.45	310.20	273.90	170.70	124.80	81.75	50.70	45.15	25.05
1.80V	1175.85	783.30	629.70	419.85	301.20	265.80	166.50	121.80	80.55	50.10	44.70	24.90

Note The above data are average values, and can be obtained within 3 charge/discharge cycles. These are not minimum values. Cell and battery designs/specifications are subject to modification without notice. Contact **US** for the latest information.

Performance Characteristics

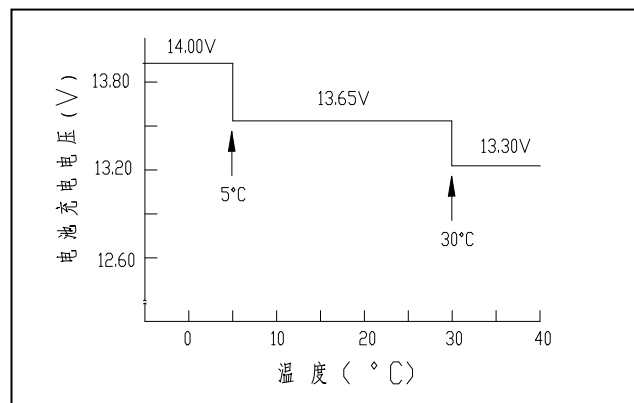
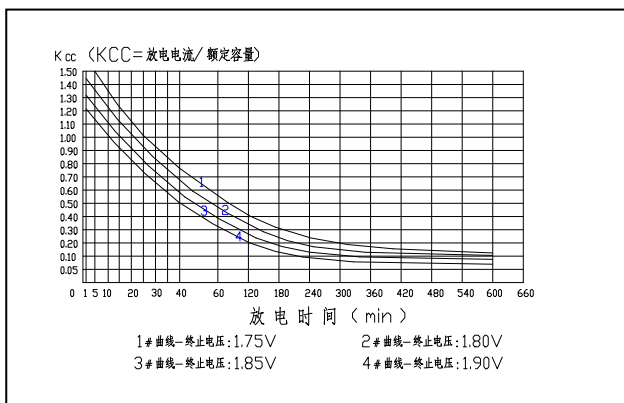
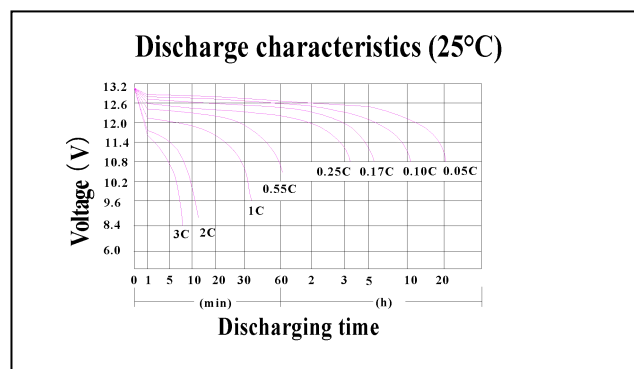
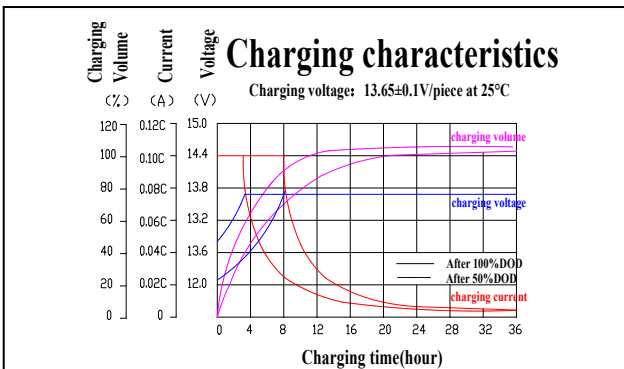
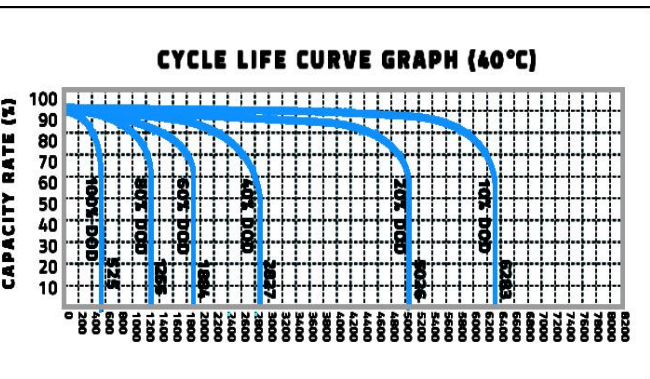
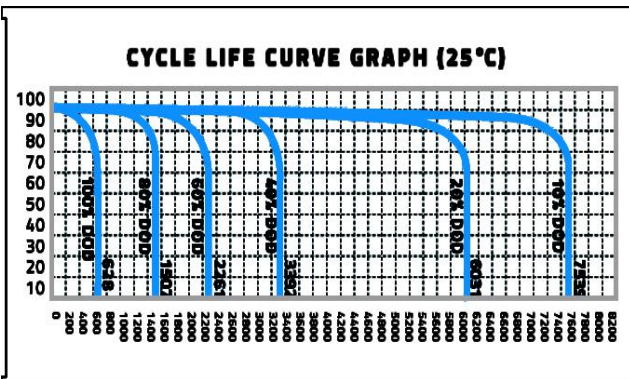
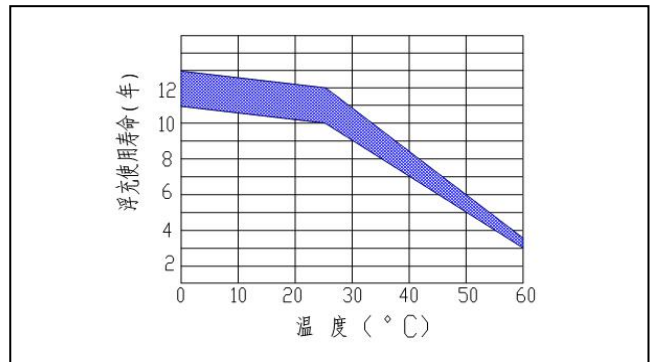
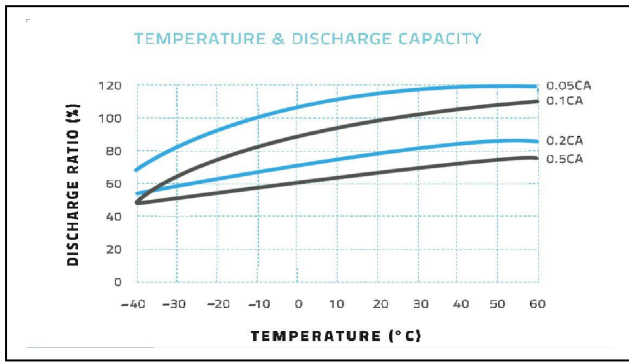

Battery Construction

Component	Positive plate	Negative plate	Container	Cover	Safety valve	Terminal	Separator	Electrolyte
Raw material	Lead dioxide	Lead	ABS	ABS	Si-Rubber	Copper	Fiberglass	Lead

Guangdong JiYi General Electric Co., Ltd.

Overseas sales office Tel: +86-020-84869873

Fax: +86-020-34628335

Domestic sales office Tel: 020-34628335

Fax: 020-34628335

E-mail: ge@gerch.cn