

Product Image

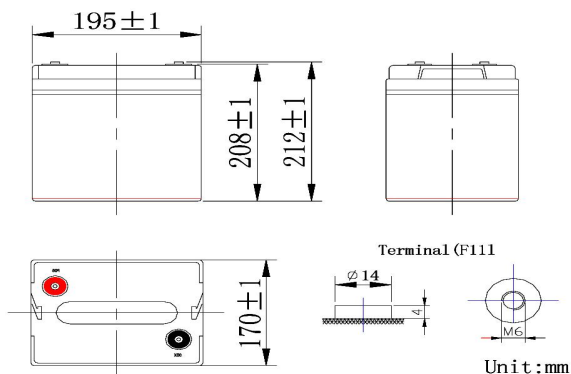

Product Dimensions



Characteristics

Nominal Voltage		6V
Nominal Capacity (10 hour rate)		200Ah
Capacity 25°C (77°F)	20 hour rate (7.22A)	222Ah
	5 hour rate (23.8A)	183Ah
	1 hour rate (86.5A)	133Ah
Full Charged Battery 25°C	Full Charged Battery 25°C	≤2.7mΩ
Capacity affected by Temperature (10 hour)	40°C (104°F)	102%
	25°C (77°F)	100%
	-20°C (-4°F)	82%
	-35°C (-31°F)	65%
after 3 month storage	after 3 month storage	90%
	after 6 month storage	80%
	after 12 month storage	62%
Charge (Constant Voltage) 25°C (77°F)	Float	Initial Charging Current Less than 50A Voltage 6.8-6.9V
	Cycle	Initial Charging Current Less than 50A Voltage 7.2-7.45V

Packaging

Battery Dimensions	Length	195mm
	Width	170mm
	Height	206mm
	Total Height	112mm
Box Dimensions	Length	210mm
	Width	184mm
	Height	256mm
Quantity Per Box		1 PC per box
Net weight Per Cell		30 kg±200g
Net weight Per Box		30kg
Gross Weight		30.5kg

Discharge Constant Current per Cell (Amperes at 77°F25°C)

F.V/Time	5min	10min	15min	30min	45min	1h	2h	3h	5h	8h	10h	20h
1.60V	672.5	448.0	337.6	210.1	150.8	133.0	81.1	59.3	38.1	23.3	20.8	11.6
1.65V	620.0	413.0	323.6	204.5	146.8	129.5	79.6	58.3	37.6	23.1	20.6	11.4
1.70V	630.5	420.0	309.5	198.9	142.6	125.9	78.1	57.1	37.1	22.9	20.4	11.3
1.75V	556.9	371.0	295.5	193.3	138.6	122.4	76.3	55.8	36.5	22.6	20.2	11.2
1.80V	525.4	350.0	281.4	187.6	134.6	118.8	74.4	54.4	36.0	22.4	20.0	11.1

Discharge Constant Power per Cell (Watts at 77°F 25°C)

F.V/Time	5min	10min	15min	30min	45min	1h	2h	3h	5h	8h	10h	20h
1.60V	1254.3	835.5	629.8	391.9	281.1	248.1	151.3	110.6	71.1	43.5	38.8	21.5
1.65V	1156.3	770.3	603.5	381.4	273.6	241.5	148.5	108.5	70.1	43.0	38.4	21.4
1.70V	1175.9	783.3	577.3	370.9	266.1	234.9	145.8	106.5	69.1	42.6	38.0	21.1
1.75V	1038.6	691.9	551.0	360.4	258.5	228.3	142.3	104.0	68.1	42.3	37.6	20.9
1.80V	979.9	652.8	524.8	349.9	251.0	221.5	138.8	101.5	67.1	41.8	37.3	20.8

Note The above data are average values, and can be obtained within 3 charge/discharge cycles. These are not minimum values. Cell and battery designs/specifications are subject to modification without notice. Contact **US** for the latest information.

Performance Characteristics

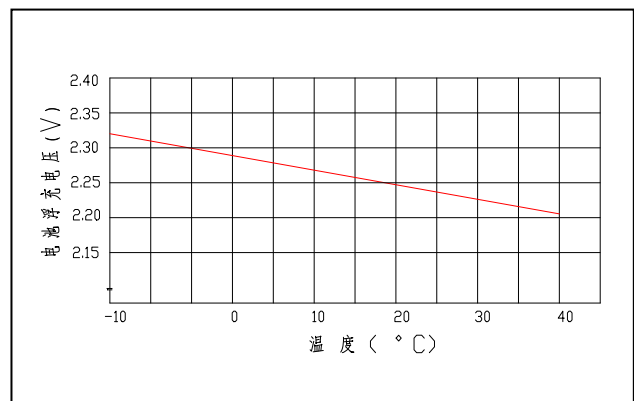
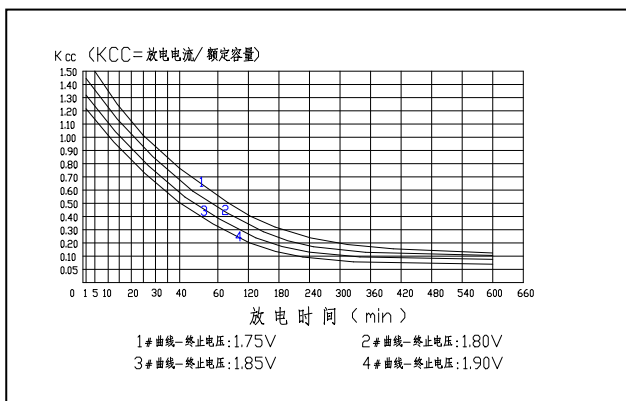
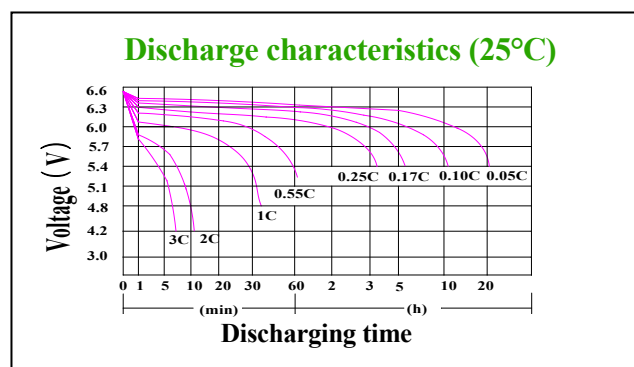
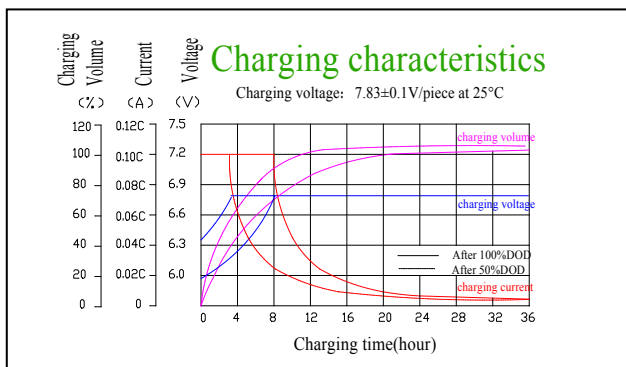
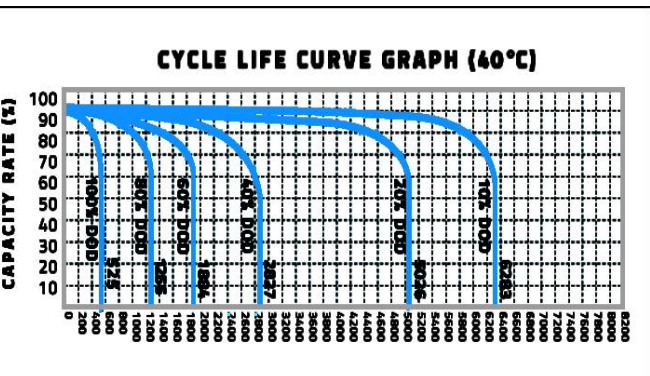
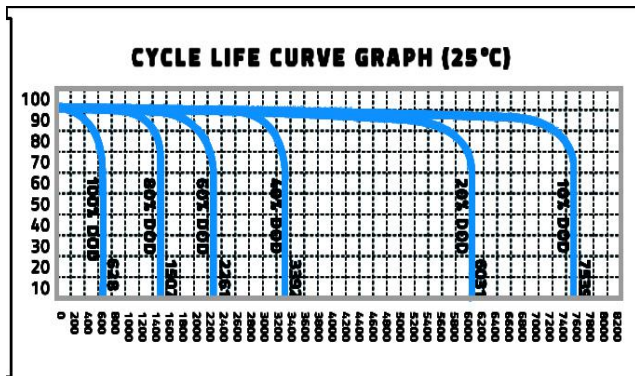
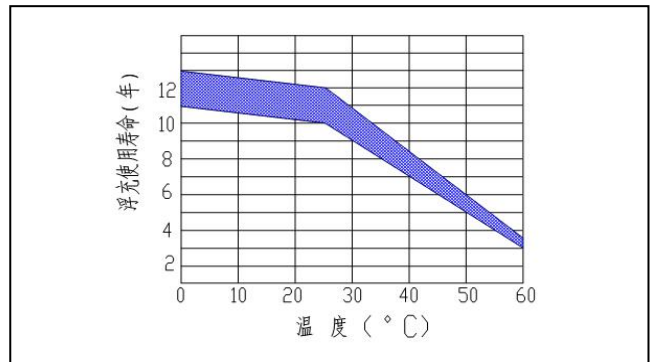
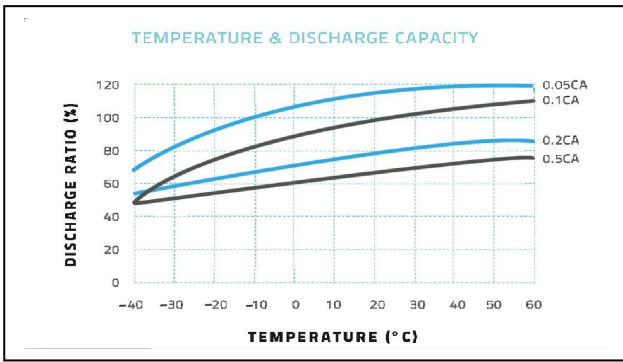

Battery Construction

Component	Positive plate	Negative plate	Container	Cover	Safety valve	Terminal	Separator	Electrolyte
Raw material	Lead dioxide	Lead	ABS	ABS	Si-Rubber	Copper	Fiberglass	Lead

Guangdong JiYi General Electric Co., Ltd.

Overseas sales office Tel: +86-020-84869873

Fax: +86-020-34628335

Domestic sales office Tel: 020-34628335

Fax: 020-34628335

E-mail: ge@gerch.cn