

Product Image

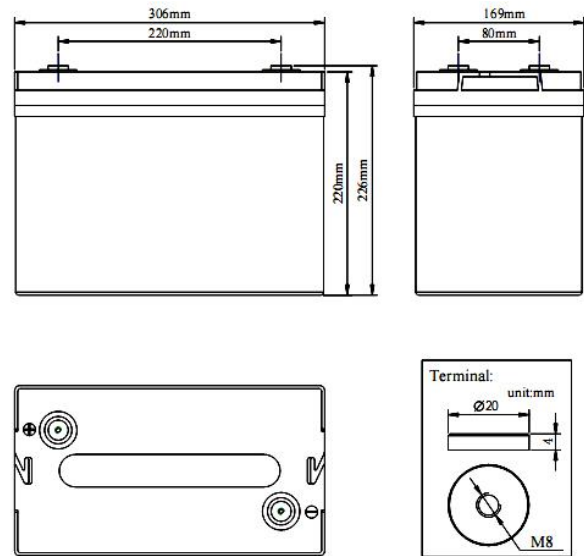

Product Dimensions



Characteristics

Nominal Voltage		6V
Nominal Capacity (20 hour rate)		200Ah
Capacity 25°C (77°F)	10 hour rate (18.0A)	180Ah
	5 hour rate (32.3A)	161.6Ah
	1 hour rate (111A)	111Ah
Internal Resistance	Full Charged Battery 25°C	≤3.0m Ω
Capacity affected by Temperature (10 hour)	40°C (104°F)	102%
	25°C (77°F)	100%
	0°C (32°F)	85%
	-15°C (5°F)	65%
Self-Discharge 25°C (77°F) Capacity	after 3 month storage	90%
	after 6 month storage	80%
	after 12 month storage	62%
Charge (Constant Voltage) 25°C (77°F)	Float	Initial Charging Current Less than 40A Voltage 6.8-6.9V
	Cycle	Initial Charging Current Less than 40A Voltage 7.2-7.45V

Packaging

Battery Dimensions	Length	306mm
	Width	168mm
	Height	220mm
	Total Height	225mm
Box Dimensions	Length	321mm
	Width	183mm
	Height	265mm
Quantity Per Box		1 PC per box
Net weight Per Cell		30.5 kg±200g
Net weight Per Box		30.5kg
Gross Weight		31.5kg

Discharge Constant Current per Cell (Amperes at 77°F25°C)

F.V/Time	5min	10min	15min	30min	45min	1h	2h	3h	5h	8h	10h	20h
1.60V	475.2	302.9	257.4	164.3	120.8	110.9	70.5	49.5	33.7	22.2	19.8	11.0
1.65V	466.6	297.4	252.7	161.4	118.6	108.9	69.2	48.6	33.0	21.8	19.4	10.8
1.70V	457.9	291.9	248.0	158.4	116.4	106.8	67.9	47.7	32.4	21.4	19.1	10.6
1.75V	449.3	286.4	243.4	155.4	114.2	104.8	66.6	46.8	31.8	21.0	18.7	10.4
1.80V	432.0	275.4	234.0	149.4	109.8	100.8	64.1	45.0	30.6	20.2	18.0	10.0

Discharge Constant Power per Cell (Watts at 77°F 25°C)

F.V/Time	5min	10min	15min	30min	45min	1h	2h	3h	5h	8h	10h	20h
1.60V	914.8	583.2	495.5	316.4	232.5	213.4	135.7	95.3	64.8	42.7	38.1	21.2
1.65V	898.1	572.6	486.5	310.6	228.3	209.6	133.2	93.6	63.6	41.9	37.4	20.8
1.70V	881.5	562.0	477.5	304.9	224.0	205.7	130.8	91.8	62.4	41.1	36.7	20.4
1.75V	864.9	551.4	468.5	299.1	219.8	201.8	128.3	90.1	61.3	40.4	36.0	20.0
1.80V	831.6	530.1	450.5	287.6	211.4	194.0	123.4	86.6	58.9	38.8	34.7	19.2

Note The above data are average values, and can be obtained within 3 charge/discharge cycles. These are not minimum values. Cell and battery designs/specifications are subject to modification without notice. Contact **US** for the latest information

Performance Characteristics

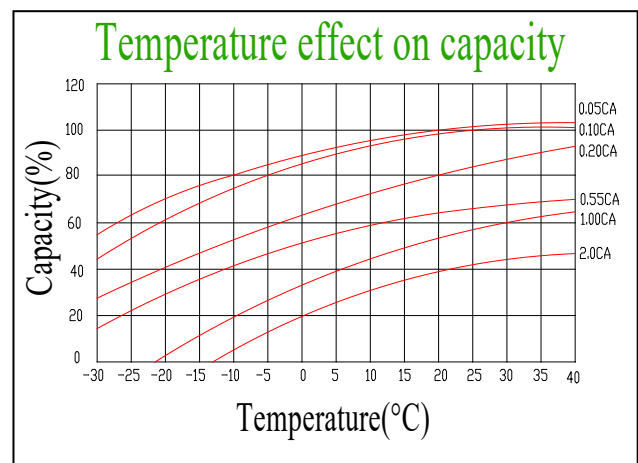
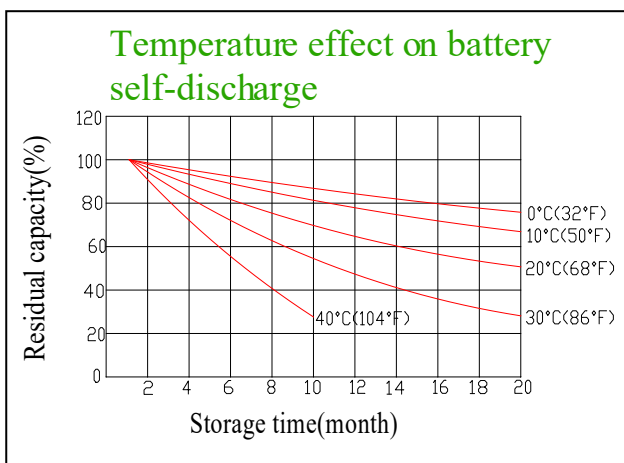
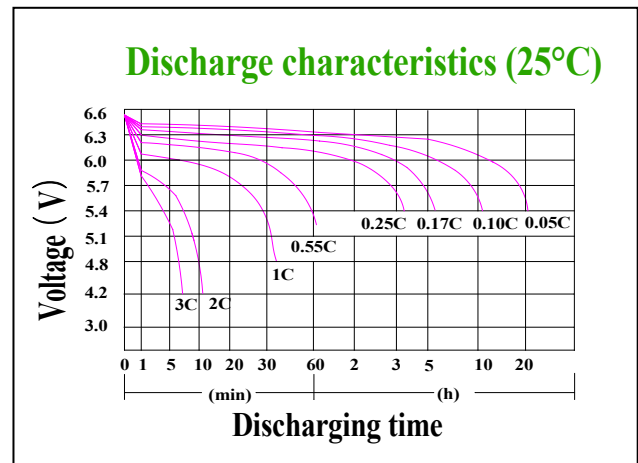
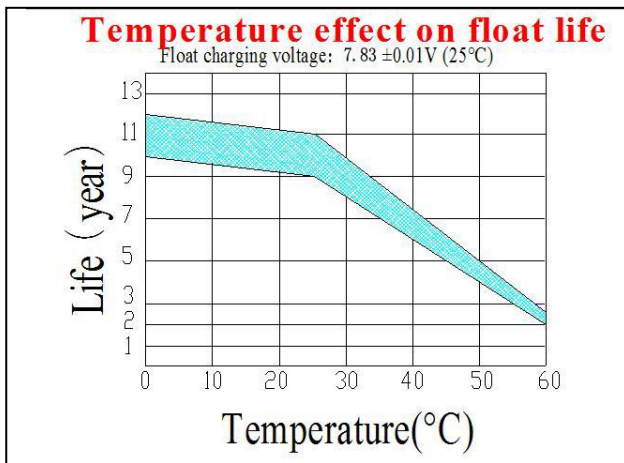
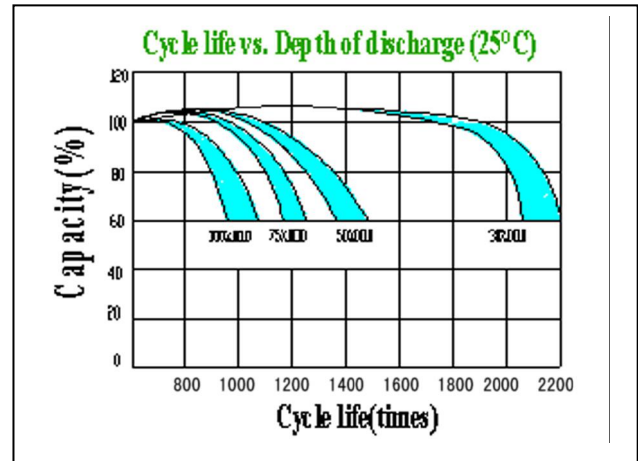
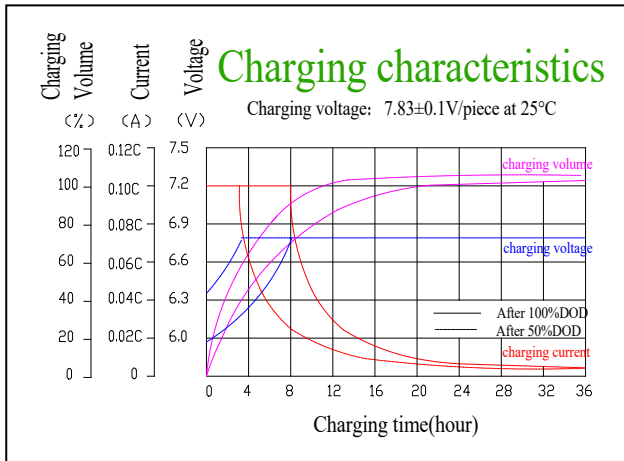

Battery Construction

Component	Positive plate	Negative plate	Container	Cover	Safety valve	Terminal	Separator	Electrolyte
Raw material	Lead dioxide	Lead	ABS	ABS	Rubber	Copper	Fiberglass	Sulfuric acid

Guangdong JiYi General Electric Co., Ltd.

Overseas sales office Tel: +86-020-84869873

Fax: +86-020-34628335

Domestic sales office Tel: 020-34628335

Fax: 020-34628335

E-mail: ge@gerch.cn