

### Product Image

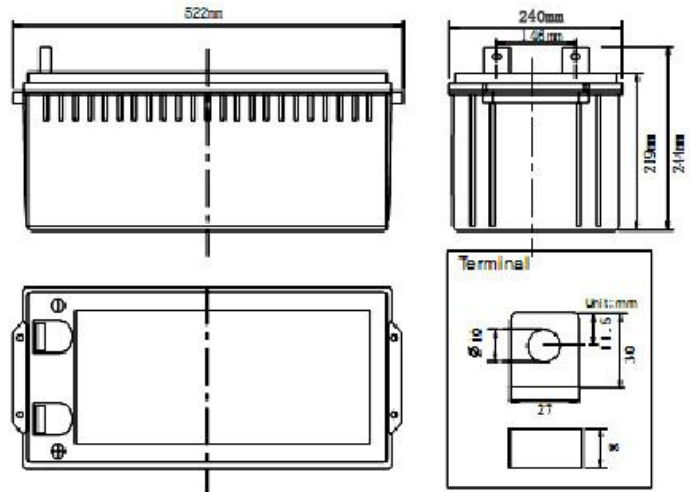

### Product Dimensions



### Characteristics

Nominal Voltage		12V
Nominal Capacity (10 hour rate)		180Ah
Capacity 25°C (77°F)	20 hour rate (9.99A)	199.8Ah
	5 hour rate (32.94A)	164.7Ah
	1 hour rate (119.7A)	119.7Ah
Internal Resistance	Full Charged Battery 25°C	≤2.7m Ω
Capacity affected by Temperature (10 hour)	40°C (104°F)	102%
	25°C (77°F)	100%
	0°C (32°F)	85%
	-15°C (5°F)	65%
Self-Discharge 25°C (77°F) Capacity	after 3 month storage	90%
	after 6 month storage	80%
	after 12 month storage	62%
Charge (Constant Voltage) 25°C (77°F)	Float	Initial Charging Current Less than 45A Voltage 13.6-13.8V
	Cycle	Initial Charging Current Less than 45A Voltage 14.4-14.9V

### Packaging

Battery Dimensions	Length	522mm
	Width	240mm
	Height	219mm
	Total Height	244mm
Box Dimensions	Length	537mm
	Width	255mm
	Height	299mm
Quantity Per Box		1 PC per box
Net weight Per Cell		49kg±500g
Net weight Per Box		49kg
Gross Weight		49.4kg

### Discharge Constant Current per Cell (Amperes at 77°F25°C)

F.V/Time	5min	10min	15min	30min	45min	1h	2h	3h	5h	8h	10h	20h
1.60V	605.3	403.2	303.9	189.1	135.7	119.8	73.0	53.4	34.3	21.0	18.72	10.39
1.65V	558.0	371.7	291.2	184.0	132.0	116.5	71.6	52.4	33.9	20.8	18.54	10.29
1.70V	567.4	378.0	278.6	179.0	128.4	113.3	70.3	51.4	33.4	20.6	18.36	10.19
1.75V	501.2	333.9	265.9	173.9	124.8	110.1	68.6	50.2	32.9	20.4	18.18	10.09
1.80V	472.9	315.0	253.3	168.8	121.1	106.9	67.0	49.0	32.4	20.2	18.00	9.99

### Discharge Constant Power per Cell (Watts at 77°F 25°C)

F.V/Time	5min	10min	15min	30min	45min	1h	2h	3h	5h	8h	10h	20h
1.60V	1128.8	752.0	566.8	352.7	253.0	223.3	136.1	99.5	64.1	39.1	34.9	19.4
1.65V	1040.6	693.2	543.2	343.2	246.3	217.4	133.6	97.7	63.1	38.7	34.6	19.2
1.70V	1058.3	705.0	519.6	333.8	239.5	211.4	131.1	95.9	62.2	38.4	34.2	19.0
1.75V	934.8	622.7	495.9	324.3	232.7	205.4	128.0	93.6	61.3	38.0	33.9	18.8
1.80V	881.9	587.5	472.3	314.9	225.9	199.4	124.9	91.3	60.4	37.6	33.6	18.6

**Note** The above data are average values, and can be obtained within 3 charge/discharge cycles. These are not minimum values. Cell and battery designs/specifications are subject to modification without notice. Contact **US** for the latest information.

### Performance Characteristics

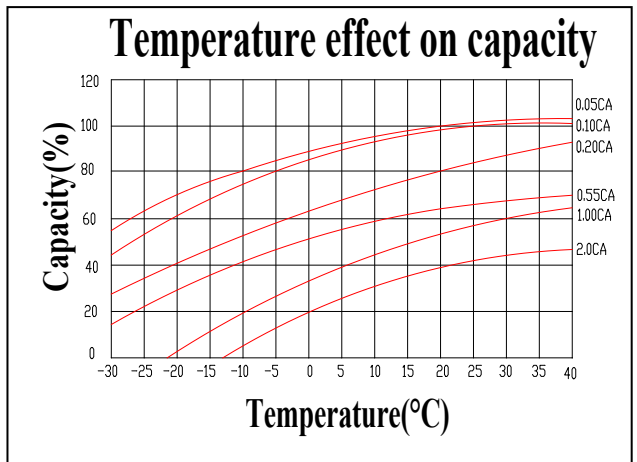
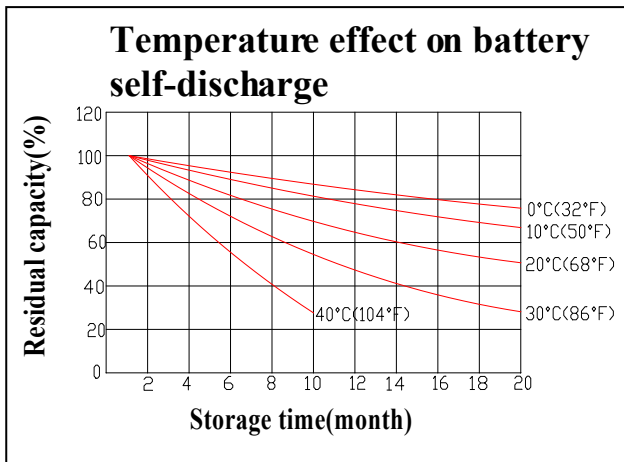
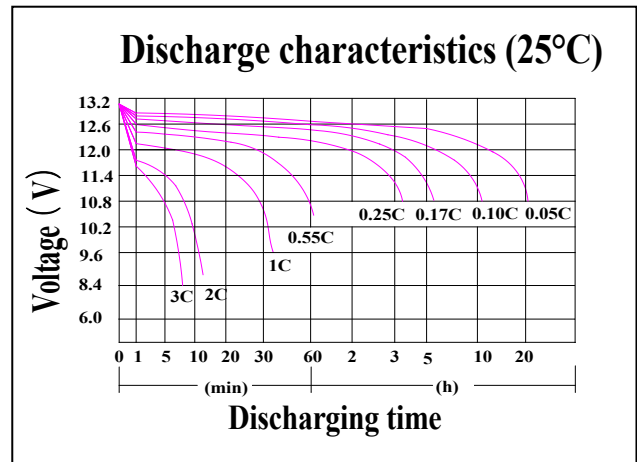
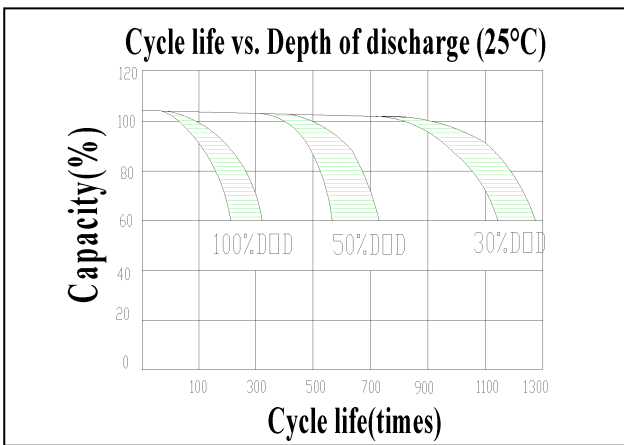
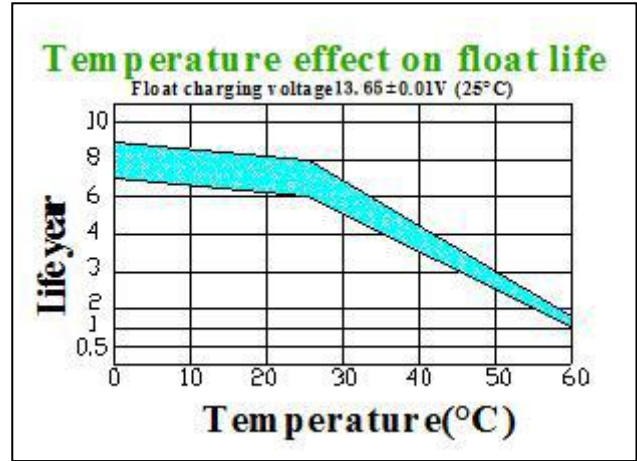
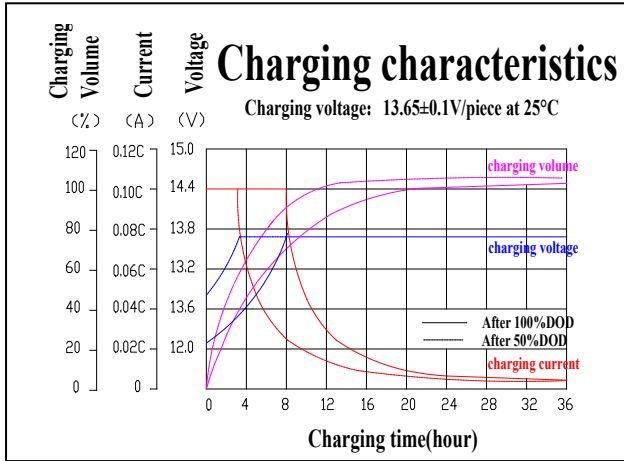

### Battery Construction

Component	Positive plate	Negative plate	Container	Cover	Safety valve	Terminal	Separator	Electrolyte
Raw material	Lead dioxide	Lead	ABS	ABS	Si-Rubber	Lead	Fiberglass	Sulfuric acid

**Guangdong JiYi General Electric Co., Ltd.**

Overseas sales office Tel: +86-020-84869873 Fax: +86-020-34628335

Domestic sales office Tel: 020-34628335 Fax: 020-34628335

E-mail: ge@gerch.cn