

Product Image

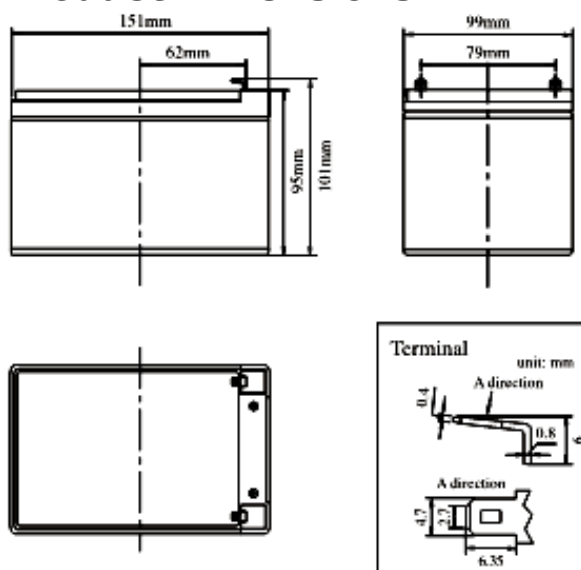

Product Dimensions



Characteristics

Nominal Voltage		12V
Nominal Capacity (20 hour rate)		14Ah
Capacity 25°C (77°F)	10 hour rate (1.34A)	13.4Ah
	5 hour rate (2.50A)	12.46Ah
	1 hour rate (9.24A)	9.24Ah
Internal Resistance	Full Charged Battery 25°C	≤14mΩ
Capacity affected by Temperature (10 hour)	40°C (104°F)	102%
	25°C (77°F)	100%
	0°C (32°F)	85%
	-15°C (5°F)	65%
Self-Discharge 25°C (77°F) Capacity	after 3 month storage	90%
	after 6 month storage	80%
	after 12 month storage	62%
Charge (Constant Voltage) 25°C (77°F)	Float	Initial Charging Current Less than 4.2A Voltage 13.6-13.8V
	Cycle	Initial Charging Current Less than 4.2A Voltage 14.4-15.0V

Packaging

Battery Dimensions	Length	151mm
	Width	99mm
	Height	95mm
	Total Height	101mm
Box Dimensions	Length	325mm
	Width	218mm
	Height	117mm
Quantity Per Box		4 pcs per box
Net weight Per Cell		3.2 kg±150g
Net weight Per Box		12.8kg
Gross Weight		13.3kg

Discharge Constant Current per Cell (Amperes at 77°F25°C)

F.V/Time	5min	10min	15min	30min	45min	1h	2h	3h	5h	8h	10h	20h
1.60V	40.46	26.01	21.67	14.45	10.36	8.93	3.95	3.85	2.62	1.72	1.54	0.82
1.65V	39.72	25.54	21.28	14.18	10.18	8.76	3.86	3.78	2.58	1.69	1.51	0.80
1.70V	38.99	25.06	20.87	13.92	9.98	8.61	3.79	3.71	2.52	1.67	1.48	0.79
1.75V	38.25	24.60	20.48	13.66	9.80	8.44	3.72	3.64	2.48	1.62	1.46	0.77
1.80V	36.78	23.65	19.70	13.13	9.42	8.12	3.58	3.50	2.38	1.57	1.40	0.74

Discharge Constant Power per Cell (Watts at 77°F 25°C)

F.V/Time	5min	10min	15min	30min	45min	1h	2h	3h	5h	8h	10h	20h
1.60V	77.88	50.06	41.71	27.80	19.95	17.19	7.59	7.41	5.04	3.32	2.97	1.57
1.65V	76.47	49.15	40.95	27.30	19.59	16.88	7.45	7.28	4.94	3.26	2.91	1.54
1.70V	75.04	48.24	40.19	26.80	19.22	16.56	7.31	7.14	4.86	3.21	2.86	1.51
1.75V	73.63	47.33	39.44	26.29	18.86	16.25	7.18	7.01	4.76	3.14	2.80	1.48
1.80V	70.80	45.51	37.91	25.28	18.14	15.64	6.90	6.73	4.58	3.02	2.70	1.43

Note The above data are average values, and can be obtained within 3 charge/discharge cycles. These are not minimum values. Cell and battery designs/specifications are subject to modification without notice. Contact **US** for the latest information.

Performance Characteristics

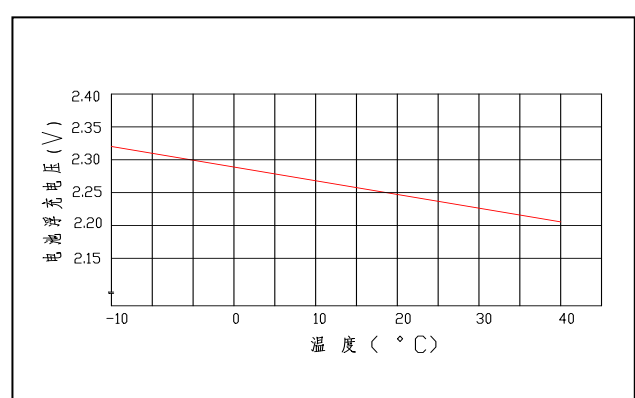
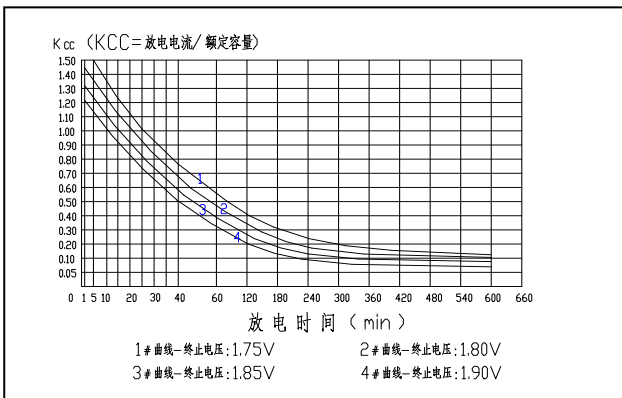
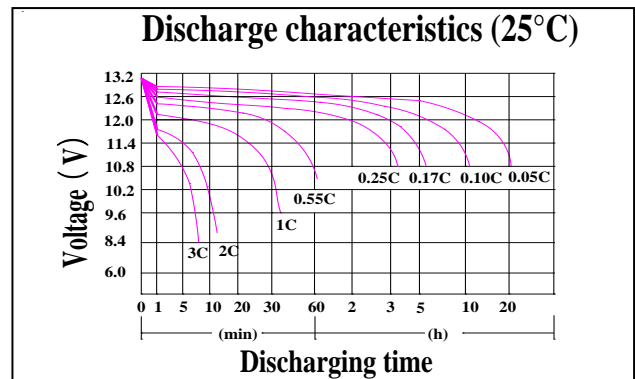
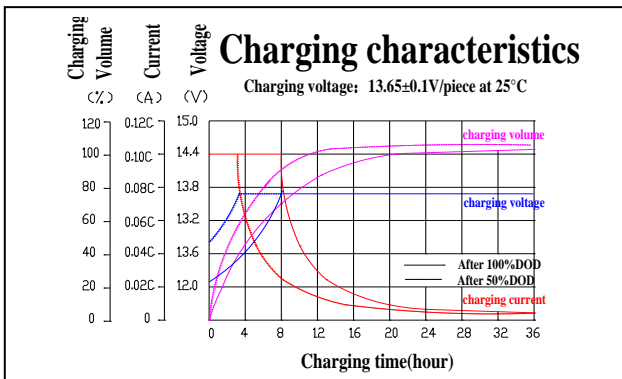
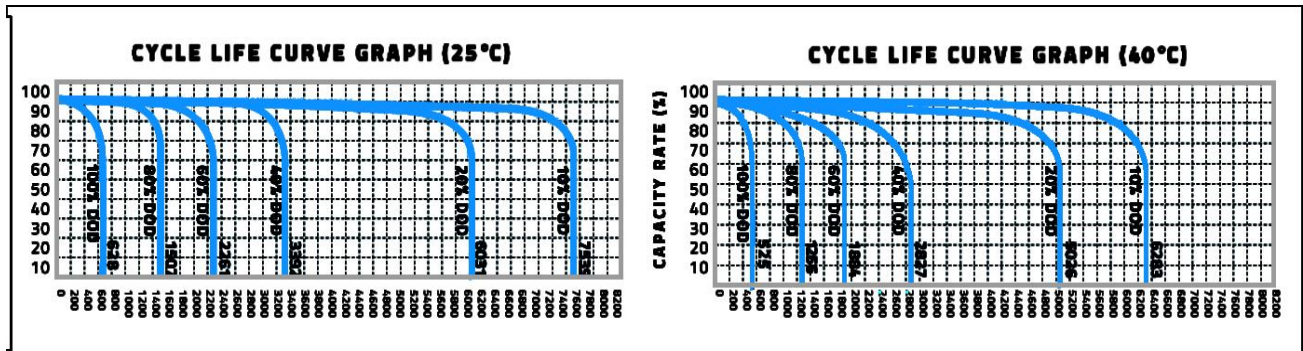
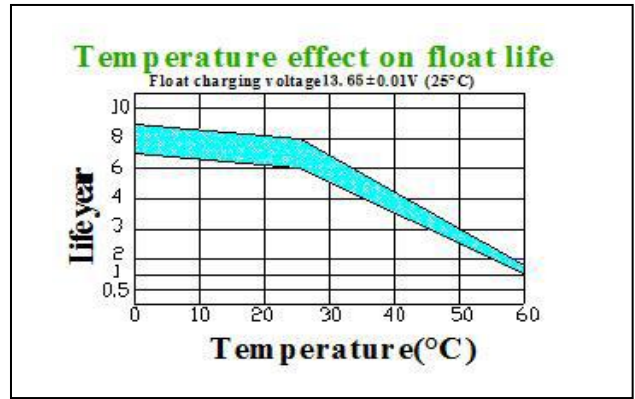
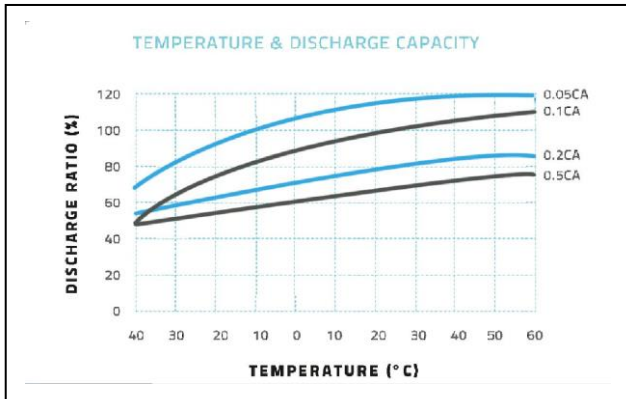

Battery Construction

Component	Positive plate	Negative plate	Container	Cover	Safety valve	Terminal	Separator	Electrolyte
Raw material	Lead dioxide	Lead	ABS	ABS	Si-Rubber	Copper	Fiberglass	Silicon

Guangdong JiYi General Electric Co., Ltd

Oversea sales office Tel: +86-020-84869873

Fax: +86-020-34628335

Domestic sales office Tel: 020-34628335

Fax: 020-34628335

E-mail:ge@gerch.cn