

Product Image

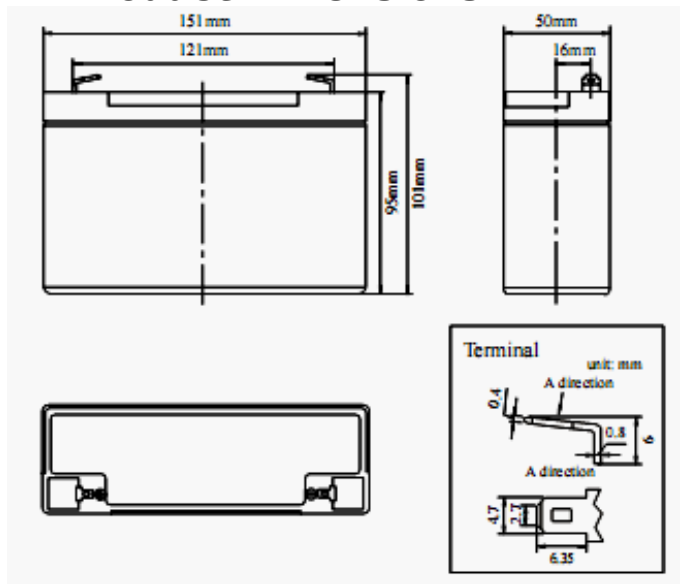

Product Dimensions



Characteristics

Nominal Voltage		6V
Nominal Capacity (20 hour rate)		12Ah
Capacity 25°C (77°F)	10 hour rate (1.15A)	11.5Ah
	5 hour rate (2.14A)	10.7Ah
	1 hour rate (7.92A)	7.92Ah
Internal Resistance	Full Charged Battery 25°C	≤12mΩ
Capacity affected by Temperature (10 hour)	40°C (104°F)	102%
	25°C (77°F)	100%
	0°C (32°F)	85%
	-15°C (5°F)	65%
Self-Discharge 25°C (77°F) Capacity	after 3 month storage	90%
	after 6 month storage	80%
	after 12 month storage	62%
Charge (Constant Voltage) 25°C (77°F)	Float	Initial Charging Current Less than 3.6A Voltage 6.8-6.9V
	Cycle	Initial Charging Current Less than 3.6A Voltage 7.2-7.5V

Packaging

Battery Dimensions	Length	151mm
	Width	50mm
	Height	95mm
	Total Height	101mm
Box Dimensions	Length	320mm
	Width	280mm
	Height	114mm
Quantity Per Box		10 pcs per box
Net weight Per Cell		1.7 kg±100g
Net weight Per Box		17kg
Gross Weight		17.5kg

Discharge Constant Current per Cell (Amperes at 77°F25°C)

F.V/Time	5min	10min	15min	30min	45min	1h	2h	3h	5h	8h	10h	20h
1.60V	34.68	22.30	18.58	12.38	8.88	7.66	3.38	3.30	2.24	1.48	1.32	0.70
1.65V	34.04	21.89	18.24	12.16	8.72	7.51	3.31	3.24	2.21	1.45	1.30	0.69
1.70V	33.42	21.48	17.89	11.93	8.56	7.38	3.25	3.18	2.16	1.43	1.27	0.67
1.75V	32.78	21.08	17.56	11.71	8.40	7.24	3.19	3.12	2.12	1.39	1.25	0.66
1.80V	31.52	20.27	16.88	11.26	8.08	6.96	3.07	3.00	2.04	1.34	1.20	0.64

Discharge Constant Power per Cell (Watts at 77°F 25°C)

F.V/Time	5min	10min	15min	30min	45min	1h	2h	3h	5h	8h	10h	20h
1.60V	66.76	42.91	35.75	23.83	17.10	14.74	6.50	6.35	4.32	2.84	2.54	1.34
1.65V	65.54	42.13	35.10	23.40	16.79	14.47	6.38	6.24	4.24	2.80	2.50	1.32
1.70V	64.32	41.35	34.45	22.97	16.48	14.20	6.26	6.12	4.16	2.75	2.45	1.30
1.75V	63.11	40.57	33.80	22.54	16.16	13.93	6.16	6.01	4.08	2.69	2.40	1.27
1.80V	60.68	39.01	32.50	21.67	15.55	13.40	5.92	5.77	3.92	2.59	2.32	1.22

Note The above data are average values, and can be obtained within 3 charge/discharge cycles. These are not minimum values. Cell and battery designs/specifications are subject to modification without notice. Contact **US** for the latest information.

Performance Characteristics

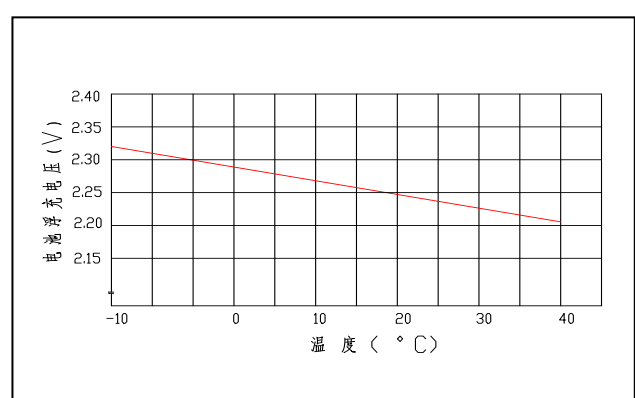
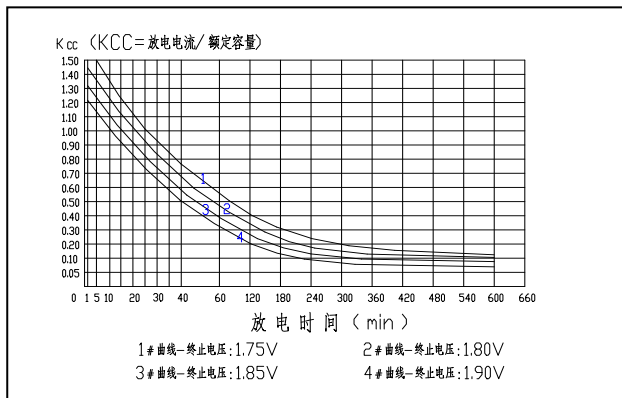
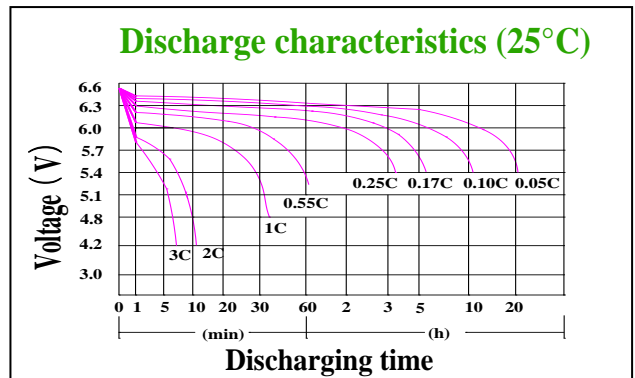
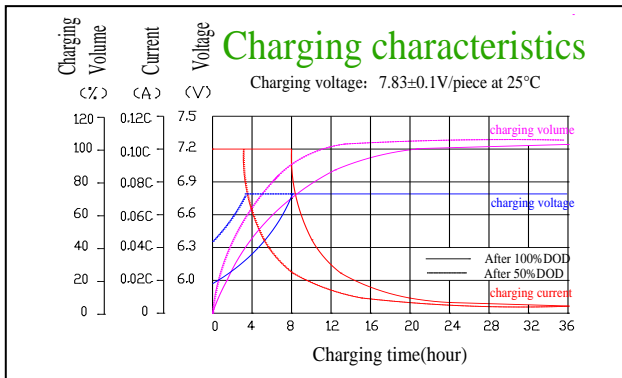
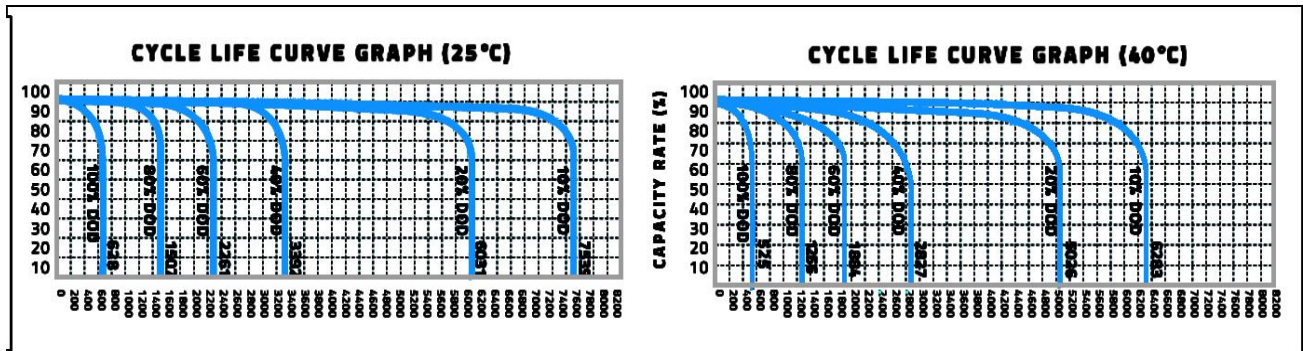
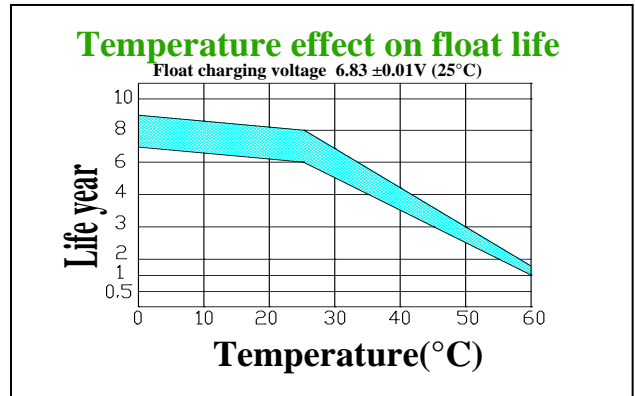
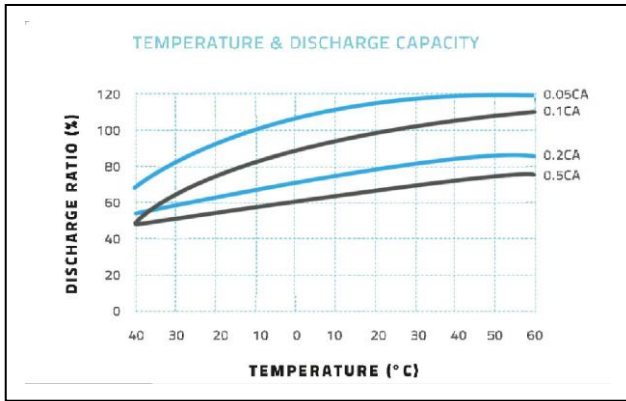

Battery Construction

Component	Positive plate	Negative plate	Container	Cover	Safety valve	Terminal	Separator	Electrolyte
Raw material	Lead dioxide	Lead	ABS	ABS	Si-Rubber	Copper	Fiberglass	Silicon

Guangdong JiYi General Electric Co., Ltd

Overseas sales office Tel: +86-020-84869873

Fax: +86-020-34628335

Domestic sales office Tel: 020-34628335

Fax: 020-34628335

E-mail: ge@gerch.cn