

### Product Image

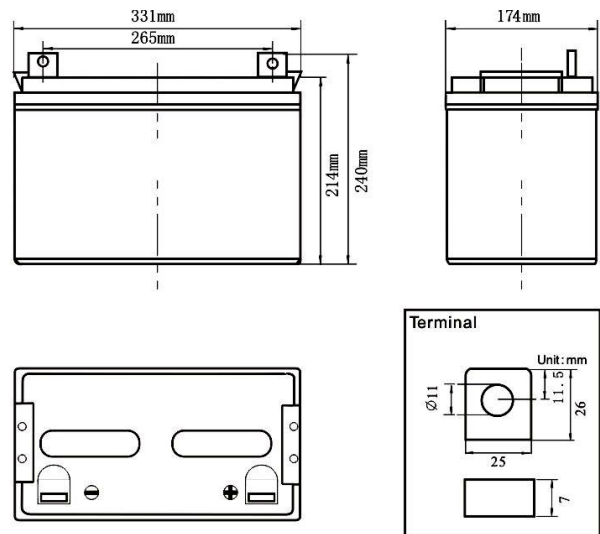

### Product Dimensions



### Characteristics

|   |                           |  |
|---|---------------------------|--|
| Nominal Voltage                                   |                           | 12V  |
| Nominal Capacity (10 hour rate)                   |                           | 100Ah  |
| Capacity<br>25°C (77°F)                           | 20 hour rate (5.55A)      | 111.0Ah  |
|   | 5 hour rate (18.3A)       | 92.5Ah   |
|   | 1 hour rate (66.5A)       | 59.4Ah   |
| Internal Resistance                               | Full Charged Battery 25°C | ≤5.0mΩ   |
| Capacity affected by<br>Temperature<br>(10 hour)  | 40°C (104°F)              | 102%   |
|   | 25°C (77°F)               | 100%   |
|   | -20°C (-4°F)              | 82%  |
|   | -35°C (-31°F)             | 65%  |
| Self-Discharge<br>25°C (77°F)<br>Capacity         | after 3 month storage     | 90%  |
|   | after 6 month storage     | 80%  |
|   | after 12 month storage    | 62%  |
| Charge<br>(Constant<br>Voltage)<br>25°C<br>(77°F) | Float                     | Initial Charging Current Less than 25.0A<br>Voltage 13.6-13.8V |
|   | Cycle                     | Initial Charging Current Less than 25.0A<br>Voltage 14.4-14.9V |

### Packaging

|                       |                 |              |
|-----------------------|-----------------|--------------|
| Battery<br>Dimensions | Length          | 339mm        |
|                       | Width           | 172mm        |
|                       | Height          | 212mm        |
|                       | Total<br>Height | 217mm        |
| Box<br>Dimensions     | Length          | 346mm        |
|                       | Width           | 188mm        |
|                       | Height          | 289mm        |
| Quantity Per Box      |                 | 1 PC per box |
| Net weight Per Cell   |                 | 30.0kg±400g  |
| Net weight Per Box    |                 | 30.0kg       |
| Gross Weight          |                 | 30.5kg       |

### Discharge Constant Current per Cell (Amperes at 77°F 25°C)

| F.V/Time | 5min  | 10min | 15min | 30min | 45min | 1h   | 2h   | 3h   | 5h   | 8h   | 10h   | 20h  |
|----------|-------|-------|-------|-------|-------|------|------|------|------|------|-------|------|
| 1.60V    | 336.3 | 224.0 | 168.8 | 105.1 | 75.4  | 66.5 | 40.5 | 29.6 | 19.1 | 11.6 | 10.40 | 5.77 |
| 1.65V    | 310.0 | 206.5 | 161.8 | 102.2 | 73.4  | 64.7 | 39.8 | 29.1 | 18.8 | 11.5 | 10.30 | 5.72 |
| 1.70V    | 315.2 | 210.0 | 154.8 | 99.4  | 71.3  | 63.0 | 39.1 | 28.6 | 18.5 | 11.4 | 10.20 | 5.66 |
| 1.75V    | 278.5 | 185.5 | 147.7 | 96.6  | 69.3  | 61.2 | 38.1 | 27.9 | 18.3 | 11.3 | 10.10 | 5.61 |
| 1.80V    | 262.7 | 175.0 | 140.7 | 93.8  | 67.3  | 59.4 | 37.2 | 27.2 | 18.0 | 11.2 | 10.00 | 5.55 |

### Discharge Constant Power per Cell (Watts at 77°F 25°C)

| F.V/Time | 5min  | 10min | 15min | 30min | 45min | 1h    | 2h   | 3h   | 5h   | 8h   | 10h  | 20h  |
|----------|-------|-------|-------|-------|-------|-------|------|------|------|------|------|------|
| 1.60V    | 627.1 | 417.8 | 314.9 | 195.9 | 140.6 | 124.1 | 75.6 | 55.3 | 35.6 | 21.7 | 19.4 | 10.8 |
| 1.65V    | 578.1 | 385.1 | 301.8 | 190.7 | 136.8 | 120.8 | 74.2 | 54.3 | 35.1 | 21.5 | 19.2 | 10.7 |
| 1.70V    | 587.9 | 391.7 | 288.6 | 185.4 | 133.0 | 117.4 | 72.8 | 53.3 | 34.6 | 21.3 | 19.0 | 10.6 |
| 1.75V    | 519.3 | 346.0 | 275.5 | 180.2 | 129.3 | 114.1 | 71.1 | 52.0 | 34.1 | 21.1 | 18.8 | 10.5 |
| 1.80V    | 489.9 | 326.4 | 262.4 | 174.9 | 125.5 | 110.8 | 69.4 | 50.7 | 33.6 | 20.9 | 18.7 | 10.4 |

**Note** The above data are average values, and can be obtained within 3 charge/discharge cycles. These are not minimum values. Cell and battery designs/specifications are subject to modification without notice. Contact **US** for the latest information.

### Performance Characteristics

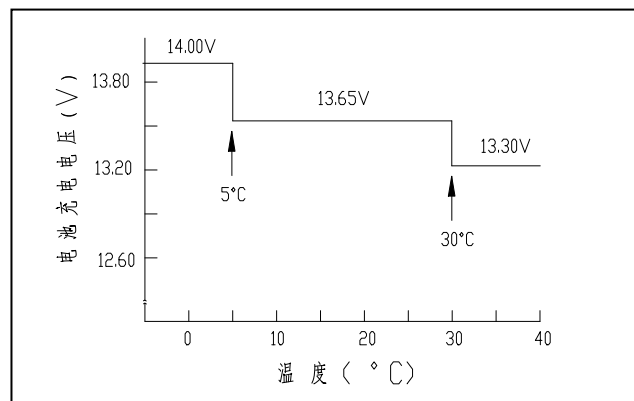
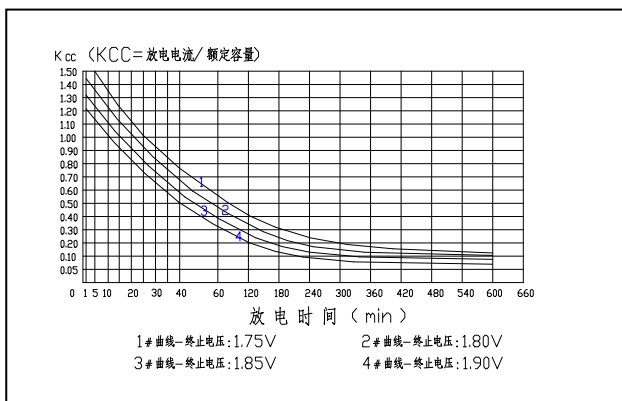
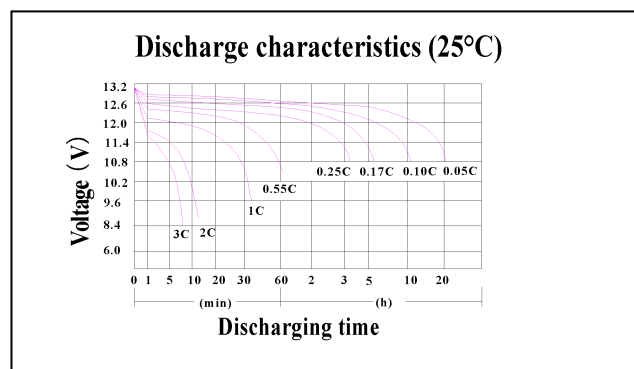
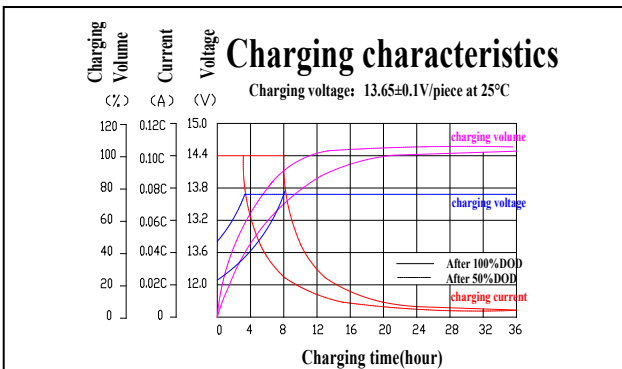
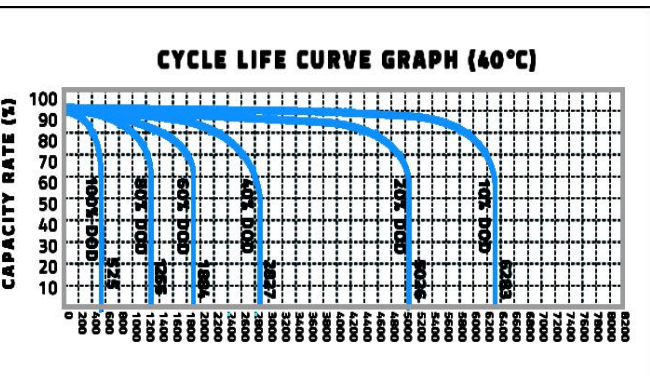
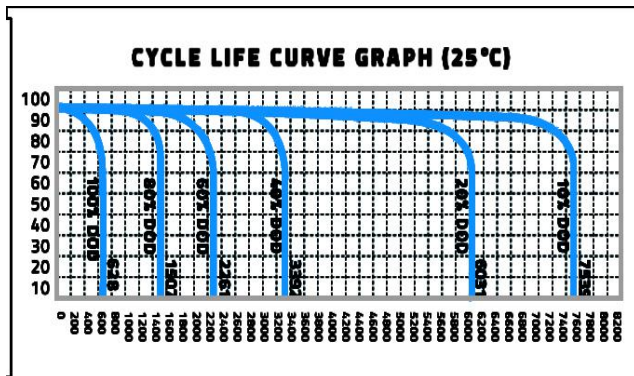
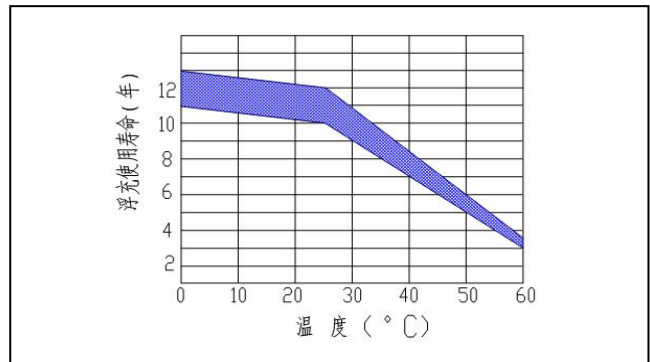
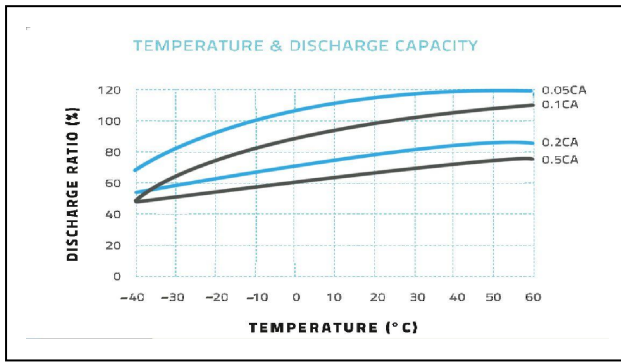

### Battery Construction

| Component    | Positive plate | Negative plate | Container | Cover | Safety valve | Terminal | Separator  | Electrolyte |
|--------------|----------------|----------------|-----------|-------|--------------|----------|------------|-------------|
| Raw material | Lead dioxide   | Lead           | ABS       | ABS   | Si-Rubber    | Copper   | Fiberglass | Lead        |

**Guangdong JiYi General Electric Co., Ltd.**

Overseas sales office Tel: +86-020-84869873

Fax: +86-020-34628335

Domestic sales office Tel: 020-34628335

Fax: 020-34628335

E-mail: ge@gerch.cn