

### Product Image

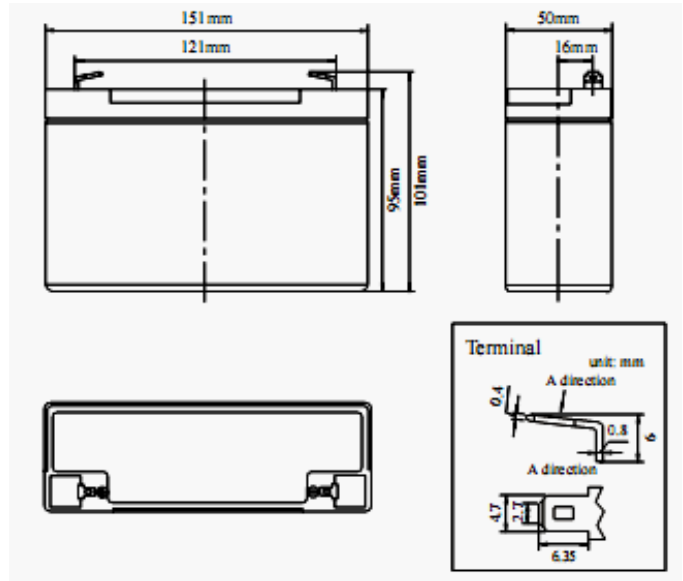

### Product Dimensions



### Characteristics

Nominal Voltage		6V
Nominal Capacity (20 hour rate)		10Ah
Capacity 25°C (77°F)	10 hour rate (0.96A)	9.57Ah
	5 hour rate (1.78A)	8.9Ah
	1 hour rate (6.6A)	6.6Ah
Internal Resistance	Full Charged Battery 25°C	≤16mΩ
Capacity affected by Temperature (10 hour)	40°C (104°F)	102%
	25°C (77°F)	100%
	0°C (32°F)	85%
	-15°C (5°F)	65%
Self-Discharge 25°C (77°F) Capacity	after 3 month storage	90%
	after 6 month storage	80%
	after 12 month storage	62%
Charge (Constant Voltage) 25°C (77°F)	Float	Initial Charging Current Less than 3A Voltage 6.8-6.9V
	Cycle	Initial Charging Current Less than 3A Voltage 7.2-7.5V

### Packaging

Battery Dimensions	Length	151mm
	Width	50mm
	Height	95mm
	Total Height	101mm
Box Dimensions	Length	320mm
	Width	280mm
	Height	114mm
Quantity Per Box		10 pcs per box
Net weight Per Cell		1.6kg±50g
Net weight Per Box		16kg
Gross Weight		16.5kg

#### Discharge Constant Current per Cell (Amperes at 77°F 25°C)

F.V/Time	5min	10min	15min	30min	45min	1h	2h	3h	5h	8h	10h	20h
1.60V	28.90	18.58	15.48	10.32	7.40	6.38	2.82	2.75	1.87	1.23	1.10	0.58
1.65V	28.37	18.24	15.20	10.13	7.27	6.26	2.76	2.70	1.84	1.21	1.08	0.57
1.70V	27.85	17.90	14.91	9.94	7.13	6.15	2.71	2.65	1.80	1.19	1.06	0.56
1.75V	27.32	17.57	14.63	9.76	7.00	6.03	2.66	2.60	1.77	1.16	1.04	0.55
1.80V	26.27	16.89	14.07	9.38	6.73	5.80	2.56	2.50	1.70	1.12	1.00	0.53

#### Discharge Constant Power per Cell (Watts at 77°F 25°C)

F.V/Time	5min	10min	15min	30min	45min	1h	2h	3h	5h	8h	10h	20h
1.60V	55.63	35.76	29.79	19.86	14.25	12.28	5.42	5.29	3.60	2.37	2.12	1.12
1.65V	54.62	35.11	29.25	19.50	13.99	12.06	5.32	5.20	3.53	2.33	2.08	1.10
1.70V	53.60	34.46	28.71	19.14	13.73	11.83	5.22	5.10	3.47	2.29	2.04	1.08
1.75V	52.59	33.81	28.17	18.78	13.47	11.61	5.13	5.01	3.40	2.24	2.00	1.06
1.80V	50.57	32.51	27.08	18.06	12.96	11.17	4.93	4.81	3.27	2.16	1.93	1.02

**Note** The above data are average values, and can be obtained within 3 charge/discharge cycles. These are not minimum values. Cell and battery designs/specifications are subject to modification without notice. Contact **US** for the latest information.

### Performance Characteristics

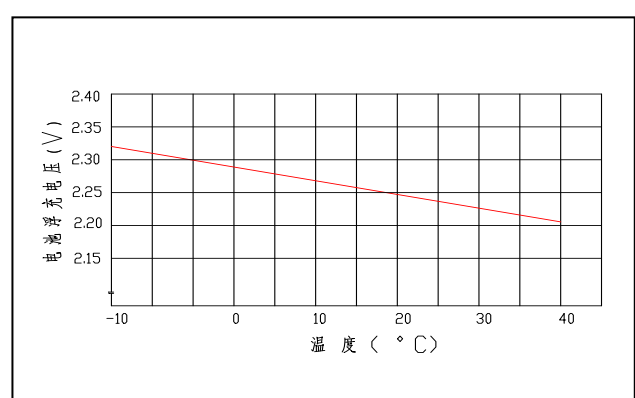
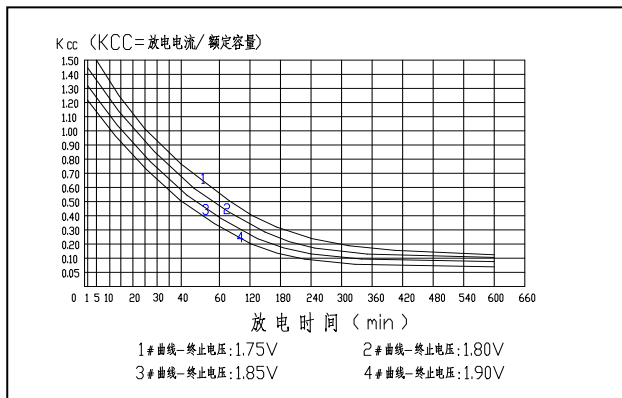
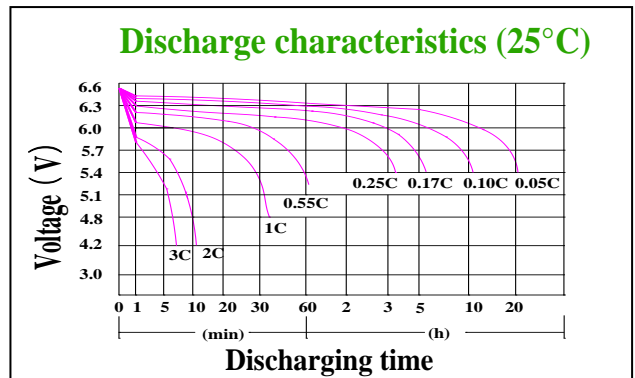
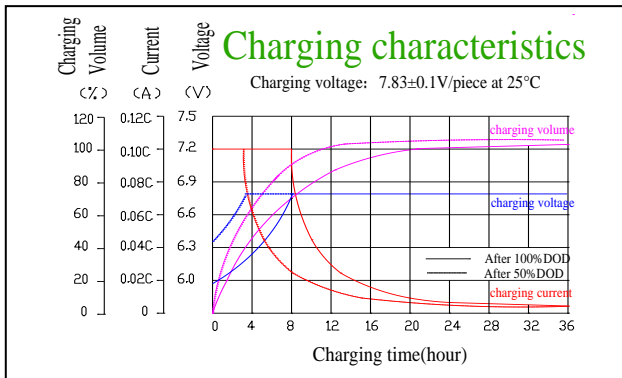
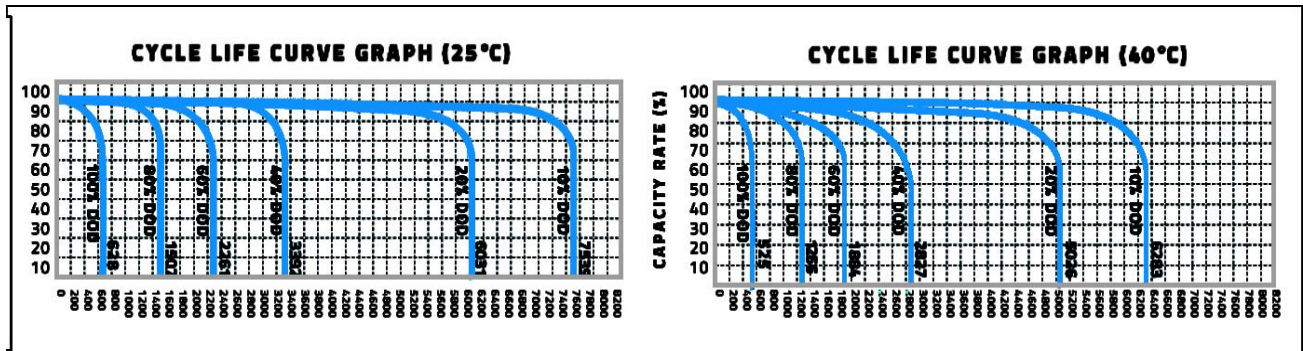
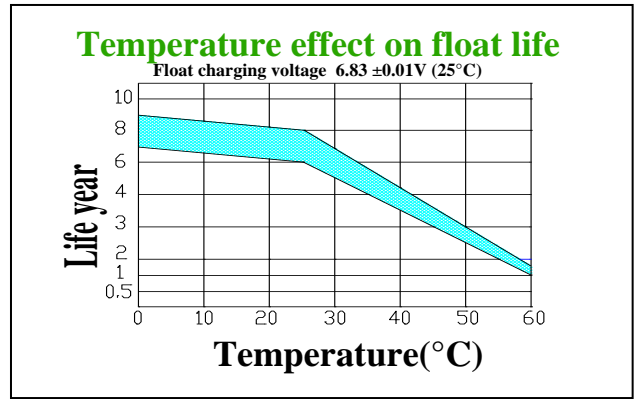
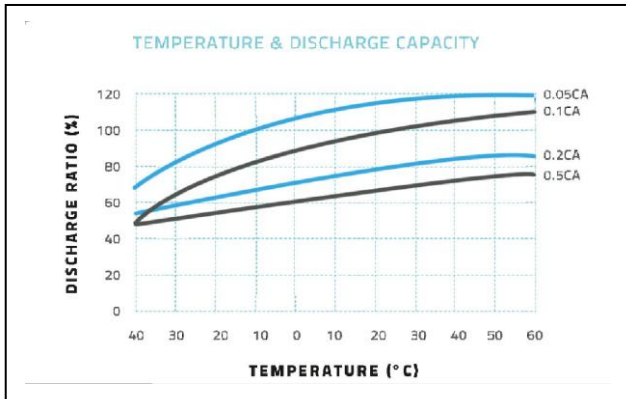

### Battery Construction

Component	Positive plate	Negative plate	Container	Cover	Safety valve	Terminal	Separator	Electrolyte
Raw material	Lead dioxide	Lead	ABS	ABS	Si-Rubber	Copper	Fiberglass	Silicon

Guangdong JiYi General Electric Co., Ltd

Oversea sales office Tel: +86-020-84869873

Fax: +86-020-34628335

Domestic sales office Tel: 020-34628335

Fax: 020-34628335

E-mail: ge@gerch.cn